

**Installation & Adjustment Manual**  
**MODEL H900**  
Prodigy & Standard Models  
For Microprocessor-Based Hydraulic  
Elevator Controls

Product Documentation that's Simple to Navigate™

**This is the Installation and Adjustment Manual** which is the guide for installation, startup and final adjustment of all Model H900 Series hydraulic elevator controllers. Other resources include:

- **Field Reprogramming Manual** for Model V900/H900 Prodigy & Standard controllers
- **Solid State Starter Manual** for controllers equipped with such starters
- **Maintenance & Troubleshooting Training Manual** provided in conjunction with Factory and Customer Site technical training classes
- **Battery Lowering Device** for controllers equipped with such device
- **Telephone Technical Support** available for Customers at no charge  
**call:** 916/428-1708; **fax:** 916/428-1728; **e-mail:** techsupport@elevatorcontrols.com
- **Onsite Product & Engineering Support** available worldwide by prior arrangement.

All information contained herein is confidential and proprietary to Elevator Controls Corporation. This document shall not be used or reproduced, in whole or part, without the prior written consent of Elevator Controls.

**Publication H900manv5 rev 7/28/17**  
© 2007 Elevator Controls Corporation

# Table of Contents

Introduction	Page 3
<b>Section 1 Overview</b>	Page 4
1.1 Product Description	Page 4
1.2 Typical Car Controller Physical Layout.	Page 5
1.3 Components general function and description	Page 7
<b>Section 2 Preparation</b>	Page 11
2.1 General Information	Page 11
2.2 Site Selection	Page 11
2.3 Environmental Considerations	Page 11
2.4 Recommended Tools and Test Equipment	Page 12
2.5 Controller Installation Guidelines	Page 12
<b>Section 3 Startup</b>	Page 15
3.1 General Information	Page 15
3.2 Startup of Elevator Controls Microprocessor Control System Model H900	Page 15
<b>Section 4 Adjustment</b>	Page 19
4.1 Final Adjustment of the Elevator Controls H900 Controller	Page 19
4.2 Check Hoistway Clearances	Page 19
4.3 Use of Test Switch	Page 19
4.4 Ez-Link Serial Communications system verification	Page 20
4.5 Running the Car on Test Mode	Page 22
4.6 Landing System Selector	Page 23
4.7 Soft Stop Timer	Page 23
4.8 Motor Limit Timer	Page 23
4.9 Multiple Door Timers	Page 23
<b>Section 5 Troubleshooting</b>	Page 24
5.1 System Not Functional In General (Car will not run)	Page 24
5.2 Microprocessor Error Reporting and Correction	Page 26
5.3 Malfunctions in the Operating System	Page 38
5.4 Proper Stepping Sequence	Page 40
5.5 Valve Problems	Page 40
5.6 Microprocessor Troubleshooting	Page 40
5.7 Operational Logic Description	Page 41
5.8 Hardware Logic	Page 43
<b>Section 6 Group System</b>	Page 45
6.1 Detailed Explanation of Group Dispatching Subsystem	Page 45
<b>Section 7 Redundancy Testing Procedure</b>	Page 47
7.1 Testing Procedures	Page 47
<b>Section 8 Maintenance</b>	Page 50
8.1 Maintenance	Page 50
8.2 Replacement Parts List	Page 50

# Introduction

## Warnings

Throughout this manual, icons will be used to call attention to certain areas of text. These icons represent safety warnings, cautions, and notes.



**WARNING:** Denotes operating procedures and practices that may result in personal injury and/or equipment damage if not correctly followed.



**CAUTION:** Denotes operating procedures and practices that may result in equipment damage if not correctly followed.



**NOTE:** Denotes useful information or procedures.

Throughout this manual it is assumed that field personnel are well qualified in the installation of elevator equipment. No attempt has been made to define terms or procedures that should be familiar to a qualified elevator mechanic.



**NOTE:** It is assumed that all switches for slowdown, stop, and over travel limits at both terminal landings have been checked for proper type, placement, and operation.



**CAUTION:** Equipment installation must be in compliance with all Local and applicable Elevator and Electrical Codes and regulations

This manual is intended only to acquaint the service technician with the information required to successfully install the microprocessor-based elevator controller. Field personnel must be familiar with all codes and regulations pertaining to the safe installation and operation of the elevator system.



**NOTE:** Installation and wiring must be in accordance with the National Electrical Code and consistent with all local codes, and National elevator codes and regulations. The AC power supply to this equipment must be provided through a proper fused disconnect or circuit breaker. Improper protection may create a hazardous condition.



**NOTE:** Wiring to controller terminals must be done in a neat and careful manner. Stranded wire conductors must be twisted together to avoid strands that would create potential shorts if left out of terminals. All controller and Field terminals and cable connectors must be checked for proper seating and tightness. When connecting flat cable connectors, be certain to match pin #1 marks (arrow symbol on connectors, red stripe on cable) to prevent damage.



**CAUTION:** Restrict access to elevator control equipment and apparatus to qualified personnel only.

# Section 1 – Overview

## 1.1 Product Description

ELEVATOR CONTROLS model H900 microcomputer based Hydraulic Controller utilizes *state-of-the-art, large scale integrated circuits* incorporated in a high performance modular circuit board design in such a way as to optimize *reliability* and *minimize installation and maintenance costs*.

The Basic Simplex System contains a Computer Microprocessor Board, P8 for standard controller or PIO9 for Prodigy Controllers, I/O Boards and a Relay Interface Board in addition to a Power Supply, Control Transformer and Starter.  
Group Controller G900-XL is available for the control of up to 16 cars.

*A simple to use, powerful diagnostic station* is built into the Computer Microprocessor Board which includes capabilities for *complete on-site re-programming* of elevator “Personality” parameters via the LCD display.

Video Display, Modem Remote Communications, and Hardcopy Elevator performance report printing are all available by means of an output connector capable of driving a standard PC, including notebook and palmtop computers.

### H900 Specifications

Number of Stops	64 stops maximum with selective door operation (typical of EC standardized system architecture)
Number of Cars in a Group	16 cars maximum
Environment Limits	32 to 104 Degrees Fahrenheit or 0 to 40 Degrees Celsius 12,000 ft (3,658 m) altitude 95% relative humidity (non-condensing)
Motor Control Options	Across the Line Y-Delta Solid State Starters (from multiple manufacturers) Variable Voltage Variable Frequency

## 1.2 Typical Car Controller Physical Layout

Figure 1.2.1 and 1.2.2 show typical layouts of the H900 Standard and Prodigy car controllers respectively; Following is a brief description of the various components of each controller in Section 1.3.

**Figure 1.2.1 – Typical H900 Standard Controller Layout**

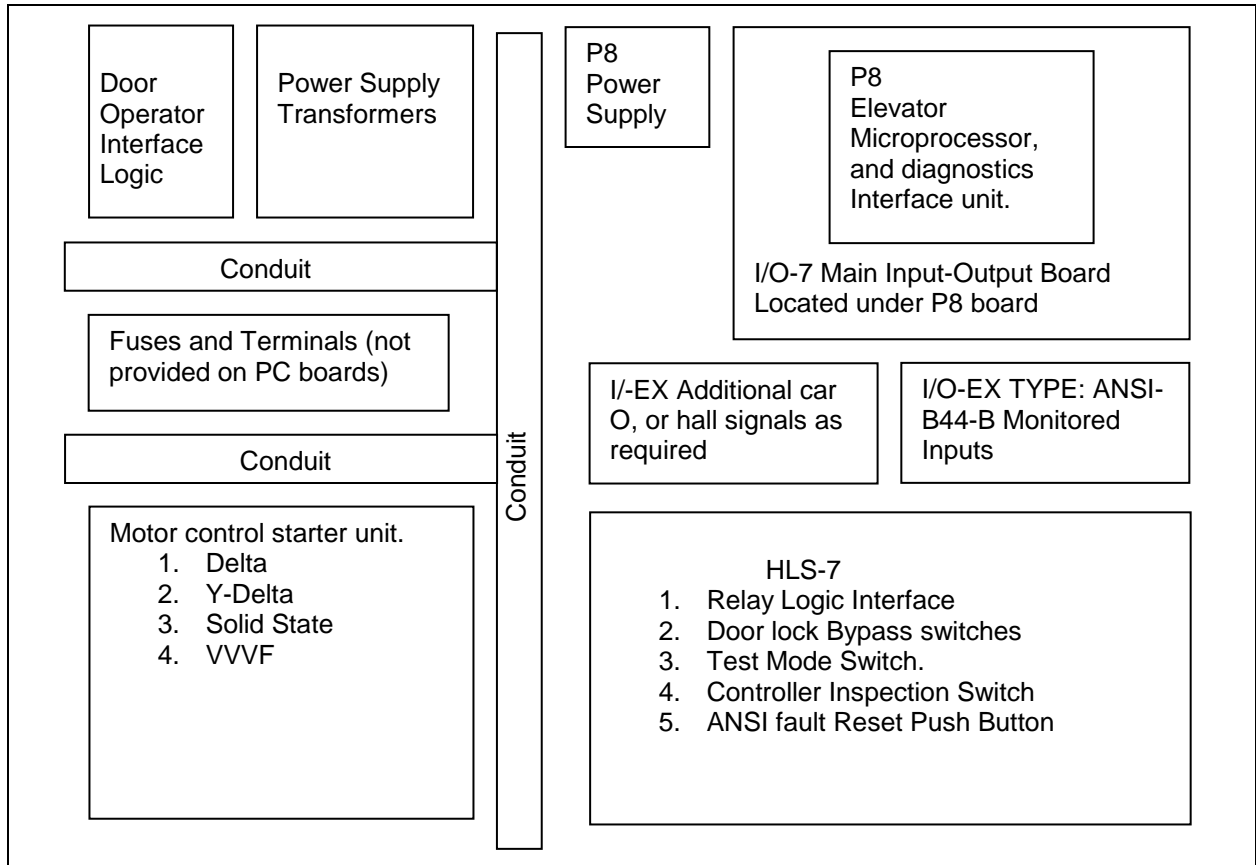

**Figure 1.2.2 - Typical H900 Prodigy Controller Layout**

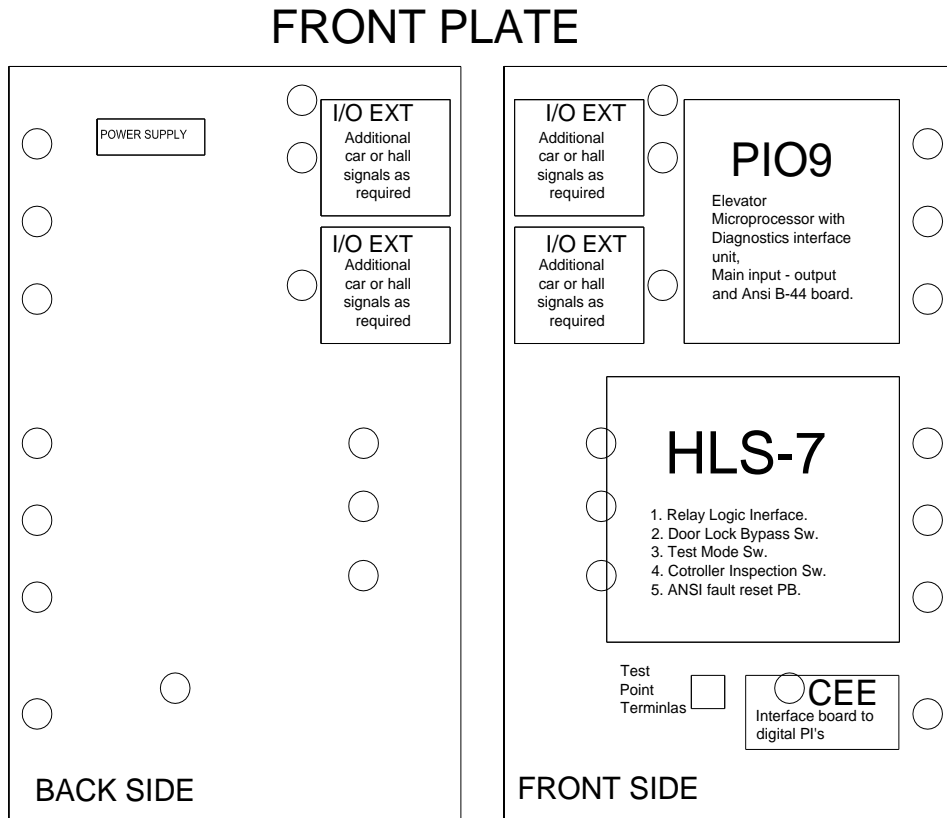

### BACK PLATE

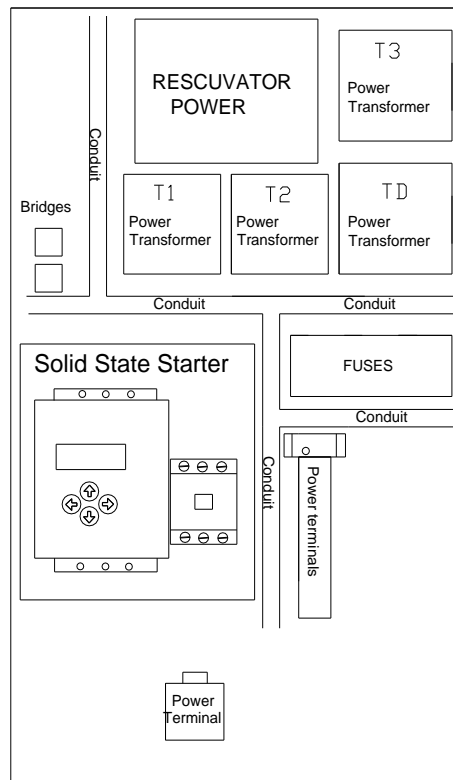

## 1.3 Components General Function and Description

### 1.3.1.1 P8 Microprocessor (H900 Standard Controller Only)

The P8 board is universal to all H900 standard series of Elevator Controls microprocessor control systems, and is used in all types of elevators from hydraulic to traction, and as a main Group dispatcher microprocessor. The P8 board utilizes high speed, microprocessor technology with a high level of system integration.

 **NOTE:** microprocessor board may also be called MPC-P8 microprocessor board.

The P8 board contains: an Onboard Menu Driving Diagnostics Tool coupled with a 2 x 16 alphanumeric display that allows full system reprogramming and diagnostics, four serial ports, a parallel port, an HSO high speed clocked serial port, and a real time clock. System ports are assigned as follows:

- COM1 (IBM) standard RS232 to drive IBM compatible systems
- COM2 (Duplex) duplex port for communication of duplex systems
- COM3 (PVF) communication with position velocity processor (Not used by H900 controller)
- COM4 (Group) communication with the group G900 processor
- HSO Communication for Ez-LINK™ serial network system P8X microprocessor
- LPT1 (Dispatcher) parallel data communication with G900 processor, when P8 is used as Dispatcher processor

The P8 board is responsible for all the decision making for the elevator's automatic mode of operation, and the monitoring of inputs and outputs for ASME-17.1A-2000 code compliance.

### 1.3.1.2 PIO9 Microprocessor (H900 Prodigy Controller Only)

The PIO9 board is universal to all Prodigy series of Elevator Controls microprocessor control systems, and is used in all types of elevators from hydraulic to traction. The PIO9 board utilizes high speed, microprocessor technology with a high level of system integration.

The PIO9 board contains: an Onboard Menu Driving Diagnostics Tool coupled with a 2 x 16 alphanumeric display that allows full system reprogramming and diagnostics, four serial ports, an HSO high speed clocked serial port, and a real time clock. System ports are assigned as follows:

- COM1 (IBM) standard RS232 to drive IBM compatible systems
- COM2 (Duplex) duplex port for communication of duplex systems
- COM3 (PVF) communication with position velocity processor (Not used by H900 controller)
- COM4 (Group) communication with the group G900 processor
- TOC and HALL serial ports for Ez- LINK™ serial network

The PIO9 board is responsible for all the decision making for the elevator's automatic mode of operation, and the monitoring of inputs and outputs for ASME-17.1A-2000 code compliance.

### **1.3.2 I/O-7 (H900 Standard Controller Only)**

The I/O-7 is the main input-output board used in all the elevator standard control systems except for the group controller. It provides all of the main inputs and outputs required to run the elevator, such as safety inputs and door control signals. Such signals are permanently labeled on the left and right sides of the board.

The connector at the right top area of the board permanently contains the first 4 position indicators, direction arrows, fire buzzer and indicator outputs which drive the actual position and fire fixtures. Different types of IO-7 boards are provided, ranging from 110AC Standard to 24DC. When replacing this board, be sure that the type and voltage match the one being replaced, and that the LED power select jumpers are placed in the same positions.

### **1.3.3 IO-EX**

The I/O-EX board provides all inputs and outputs that cannot be accommodated within the I/O-7 or PIO9 board, including car calls, hall calls, hall gongs, position indicators, etc. Voltage and LED power select jumper positions are critical (as with the I/O-7 above) so care must be exercised when replacing this board. Note that the I/O-EX may not be present in all control panels.

### **1.3.4 IO-EX-B44-B (H900 Standard Controller Only)**

The I/O-EX-B44-B board provides ASME-17.1A-2000 redundancy inputs and outputs. Voltage and LED power select jumper positions are critical (as with the I/O-7 above) so care must be exercised when replacing this board. Note that the I/O-EX-B44-B- may not be present in all standard control panels.

### **1.3.5 HLS-7**

The HLS-7 board is the main relay panel board, providing all the relay logic to interface to the elevator system door control, starters, selector, etc. It should be noted that the HLS-7 does not contain any “Smart” logic. It is a basic board that has been developed to replace point-to-point wiring with a more cost effective and reliable solution. The HLS-7 is configured per job using onboard clad cuts, and jumper configurations.



**NOTE:** The COP and TOC boards are used when the elevator control system is designed with serial communications to the top of the car and the car-operating panel. The hall boards are used when the elevator control system is designed with serial communications to the hall stations. Skip 1.3.6 to 1.3.10 for standard or Prodigy, non-serial elevator systems, without “Ez-LINK”.

### **1.3.6 COP**

The COP microprocessor board gathers all signals from the COP buttons such as car calls, door open and door close buttons, fire service, etc and transmits such information via RS-485 to the TOC board. It also receives all output information for car call outputs, passing chime, fire indicators, etc. from the TOC through the same RS-485 communications channel.



The COP board serves as interconnection point for signals, that can't be transmitted via serial communication, on their way to the traveling cable. Examples include emergency stop switch bypass, in car inspection, etc.

The COP board is linked to the TOC board via two twelve pin terminal connectors, housing all interconnects and shielded communication twisted pairs. When replacing the COP board, make sure that all board configuration jumpers are placed matching those on the board being replaced.

### **1.3.7 TOC**

The TOC microprocessor board gathers all signals from the top of car including the selector unit, door operator limit switches, load weighing device, car top inspection station, etc. It also receives all information from the COP board front (and rear, if elevator has rear doors) via an RS-485 channel dedicated for communications between TOC and COP boards. This information is then combined with locally gathered information, and transmitted via RS-422 to the P8X board for standard controllers or to the PIO9 for Prodigy controllers.

The TOC board receives all output and control information from the P8X or PIO9 for door control and other information on its way to the COP board through the same RS-422 communications channel.

The TOC board serves as interconnection point for signals, that can't be transmitted via serial communication, on their way to the traveling cable. Examples include emergency stop switch bypass, in car inspection, power supplies etc.

The TOC board is linked to the elevator controller via traveling cable. This cable contains three ten pin terminal connectors (which house all interconnects) and two sets of two twisted shielded pairs for communication.

When replacing the COP board, make sure that all board configuration jumpers are placed matching those on the board being replaced.

### **1.3.8 COP-EX**

The COP-EX board is a sixteen general input/output board that is used to accommodate signals not being housed by the COP or the TOC board such as car calls, attendant service, line per floor position indicators, etc.

When replacing the COP board, make sure that all board configuration jumpers are placed matching those on the board being replaced.

### **1.3.9 HALL**

The HALL board is used at each landing in a multi-drop configuration. This board gathers hall call information, per opening, and transmits this information to the P8X or PIO9 board via RS-485 communication path. It also receives information that illuminates and extinguishes hall calls indicator lights and sounds hall gongs.



**CAUTION:** The HALL board is configured for a particular floor layout through SW1, an eight-switch pack (dip switch). When replacing the HALL board, make sure the dipswitch positions match those on the board being replaced, or permanent damage to one or more boards in the hall loop may occur.

### **1.3.10 P8X (H900 Standard Controller Only)**

The P8X board is attached to the back of the P8 main elevator microprocessor. It communicates with the P8 via a high-speed port, HSO. The P8X function is to gather all information from the elevator serial network, from the COP-TOC, and hall station HALL boards, which is then conveyed to the elevator microprocessor. The P8X board also receives all process commands from the P8 board and distributes commands on the network, relieving the P8 microprocessor from any communications burden.

### **1.3.11 Power Supply**

The power supply has a single linear output that provides +5VDC for all microprocessor logic, and provides power to boards including P8, or PIO9, IO-6, IO-EX-B44-B and IO-EX. Typical part: Power-One HB5-3/OVP, 3 Amps @ 5VDC.

### **1.3.12 Power Supply Transformers**

Power supply transformers are provided as necessary, according to the power requirements of each individual job, to step down and/or provide power isolation from the main AC power line.

### **1.3.13 Door Operator Interface Logic**

Logic is provided as required for control of the various door operators and configurations used in the industry.

### **1.3.14 Fuses and Terminals**

Fuses, terminals, and any miscellaneous job-specific circuits that are not part of the standard PC board set are provided as required for each specific job.

### **1.3.15 Motor Control Starter Unit**

A motor starter unit required for control of the pump motor is provided. This unit is capable of being configured to control various starters from a simple Across the Line starting (delta), Y-Delta Line Starting, to solid-state control, or a sophisticated Variable Voltage Variable Frequency drive unit.

# Section 2 – Preparation

## 2.1 General Information

This section contains important instructions and recommendations pertaining to the site selection, environmental considerations, and wiring guidelines to ensure a successful installation.

## 2.2 Site Selection

While selecting the best location for the controller equipment, take into account the following factors:

- a. Make sure the control system is placed logically, while taking into consideration the rest of the equipment location.
- b. Provide adequate working space for installation, wiring, and maintenance of the control system. Please note that rear access is not required on Elevator Controls standard control systems.
- c. Do not install equipment in a hazardous location.
- d. Do not install equipment in areas or on surfaces where it will be subject to vibration as the control systems contains parts, such as relays in sockets, whose functions may be adversely affected by vibration.
- e. Provide adequate lighting and working space for comfort and efficiency; a telephone line is desirable for access for optional remote diagnostics, as well as more efficient access to Elevator Controls factory technical support if required.

## 2.3 Environmental Considerations

For proper operation and longevity, the elevator control system should be installed according to the following requirements:

- a. The temperature inside the control system enclosure should be maintained between 32 to 104 degrees Fahrenheit (0 to 40 degrees Celsius). Higher or lower temperatures will reduce the life of the system and may prevent the system from functioning normally. Provide air-conditioning if required.
- b. The air in the machine room should be free of corrosive gases. Air should be sufficiently dry to prevent condensation from moisture. NEMA 4 or NEMA 12 enclosures with integral air-conditioning units are available for these applications.
- c. Avoid placing any control system cabinet or component near windows to prevent severe weather conditions from damaging the equipment.
- d. Extreme levels of Radio Frequency (RF) radiation should be avoided. Radio Frequency Interference (RFI) may interfere with the operation of the control system. Elevator Controls hydraulic control systems have been tested by CKC Laboratories, Inc. Report Number IM00-029 and found to be in compliance with EN61000-4-2, EN61000-4-3 and EN61000-4-4 in accordance with EN12016 regulations.



**NOTE:** Hand-held communications devices used close to the system computers may generate disruptive RF interference.

## 2.4 Recommended Tools and Test Equipment

The following tools are recommended for installation of the H900 control system:

- a. Digital multi-meter
- b. Assorted electronic tools such as pliers, cutters, flashlight, Elevator Controls small screwdriver (supplied with each controller), etc
- c. Amp-Prove probe-type ammeter
- d. Telephone
- e. Test weights
- f. Control system “as built” wiring prints
- g. This manual
- h. Model V900/H900 Prodigy & Standard P8 Field Reprogramming Manual
- i. Solid State Starter Manual (for controllers containing a solid state starter)
- j. Battery Lowering Device Manual (for controllers equipped with such device)
- k. Oscilloscope and Meg-Ohmmeter may be desirable for advanced troubleshooting (rarely required)

## 2.5 Controller Installation Guidelines



**NOTE:** It is very important to follow control system wiring guidelines to prevent problems with interference and line pollution.



**NOTE:** Wiring to controller terminals must be done in a neat and careful manner. Stranded wire conductors must be twisted together to avoid strands that would create potential shorts if left out of terminals. All terminals and cable connectors must be checked for proper seating. When connecting flat cable connectors be certain to match pin #1 marks (arrow symbol on connectors, red stripe on cable) to prevent damage.





**CAUTION:** Restrict access to elevator control equipment and apparatus to qualified personnel only.

There are four different entry points that should be maintained separately while wiring the control system:

- a. Power wiring: the line power coming from the elevator service disconnect with power ground.
- b. Motor wiring: power to pump motor and power ground.

- c. Safety and Logic wiring: all wiring to fixtures and switches, as well as cross-connect signals from one car to another in a multi-car group system.
- d. Communication cables: communication cables run from one controller to another in a group of two or more cars.

 **NOTE:** Study your control system layout to achieve the best arrangement, keeping the four entry points separated and positioned logically to suit the particular control system you will be installing. Following are the proposed layout for wiring a standard and Prodigy controller.

 **NOTE:** The standard NEMA-1 enclosure provided for H900 Standard or Prodigy controllers includes factory knockouts, which suggest locations for wiring entry points. These knockouts are located as follows: one on the top right side of the enclosure for the communication cable; and two on each side of the lower portion of the enclosure for other required wiring, Figures 2.1 & 2.2.

**Figure 2.1 – Typical H900 Standard Controller Wiring Layout**

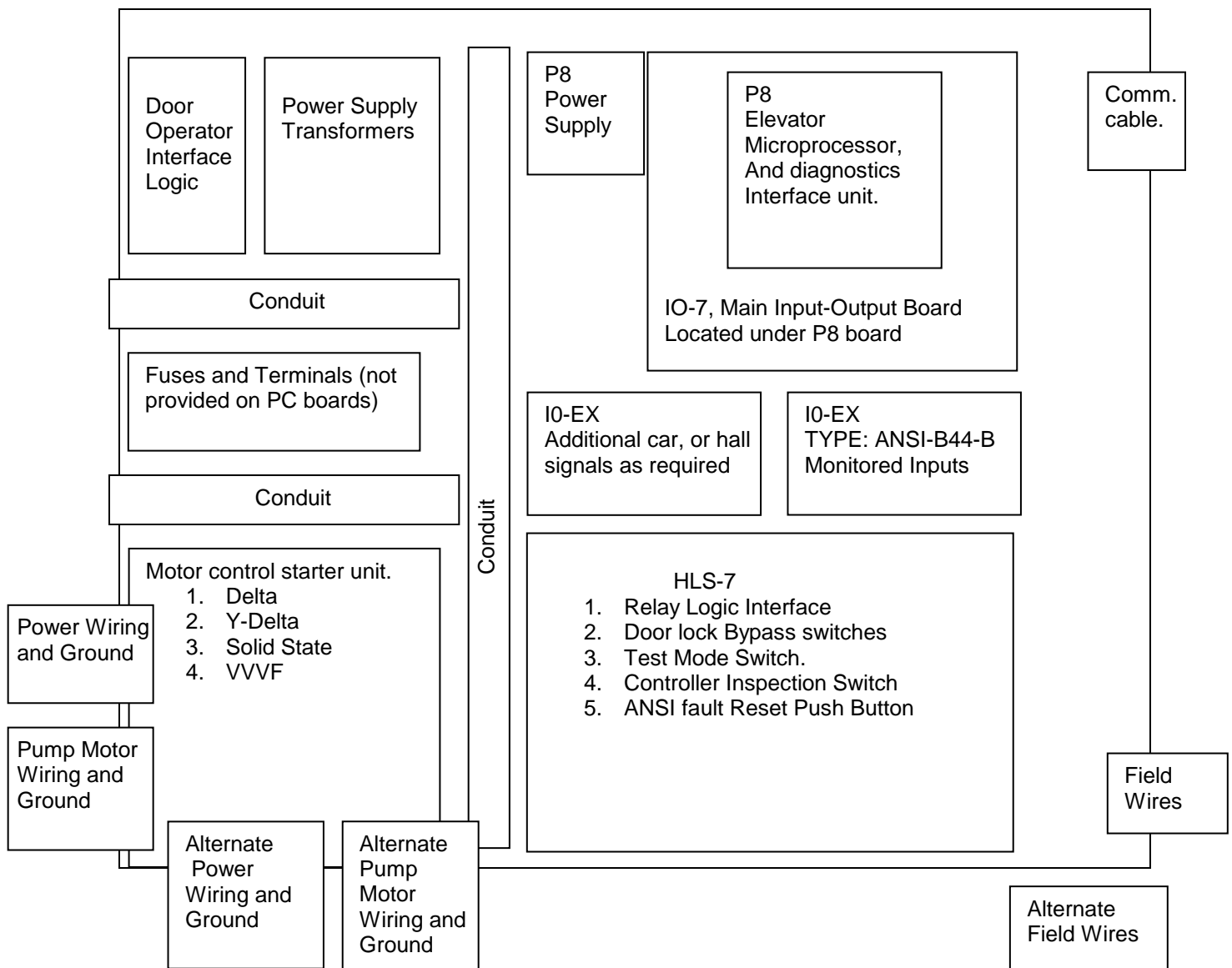

**Figure 2.2 – Typical H900 Prodigy Controller Wiring Layout**

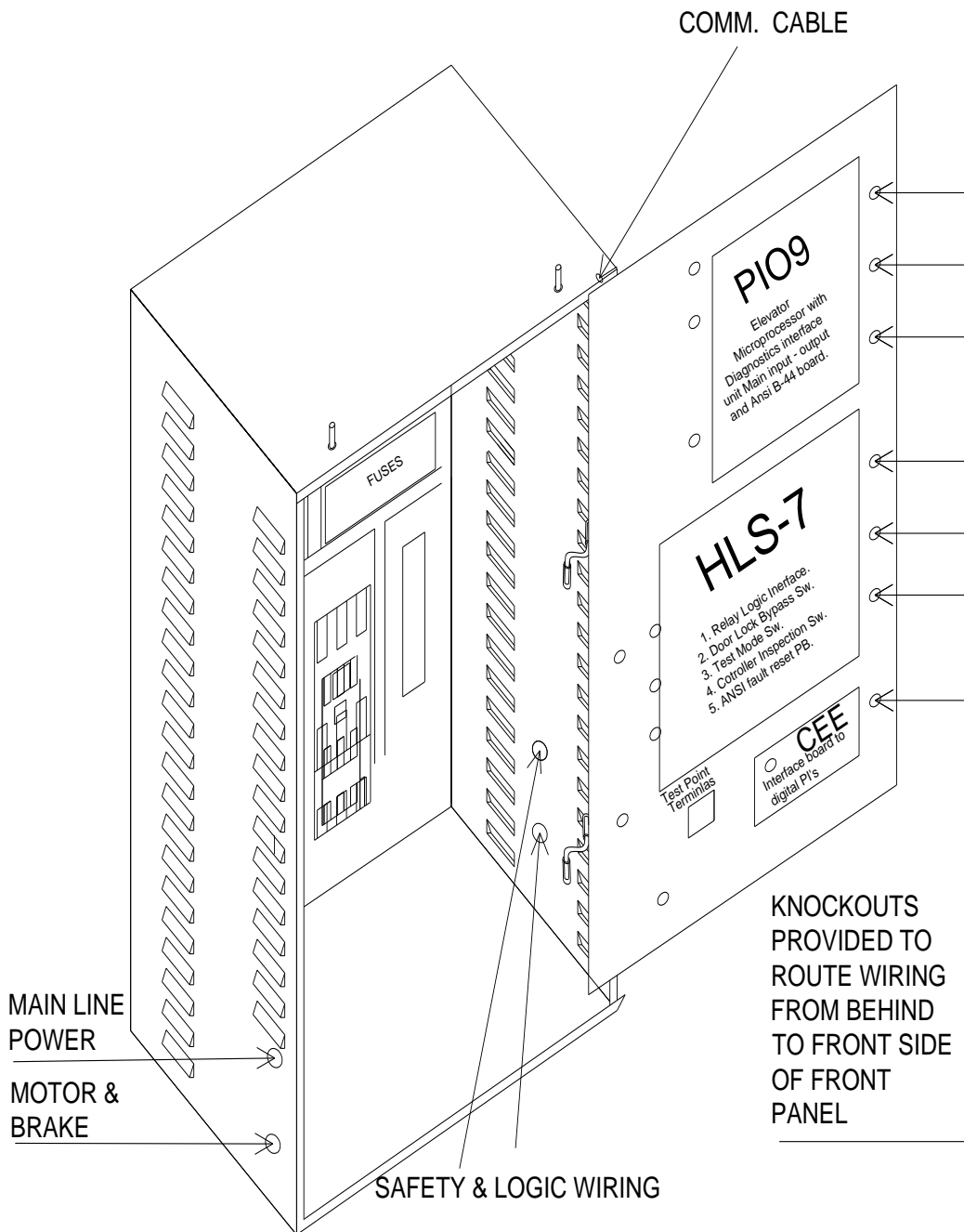

# Section 3 – Startup

## 3.1 General Information

Protect printed circuit boards from dust and foreign materials. Remove main fuses.

Complete controller mounting, installation and wiring. Observe controller field terminal locations in relation to wiring ducts in order to determine optimum locations for wiring to enter the control equipment enclosure.



**CAUTION:** Use care to protect circuit boards from metal debris when cutting.

## 3.2 Startup of H900 Microprocessor Control System



**NOTE:** These are not instructions for final adjustment.

In the following instructions it is assumed that all hatch doors are closed but not necessarily locked and that all hoistway and machine room wiring is complete. Correct any inadequacy before proceeding further.

These instructions also assume that the installer has a working knowledge of electrical troubleshooting. Follow prescribed procedure carefully.

If the elevator does not respond as expected, check the circuits according to your ability. If you can't locate the problem in a reasonable time, call in an adjuster or serviceman with advanced troubleshooting experience. Proceed with caution.



**NOTE:** You will find multiple LED indicators on PC boards and onboard computer diagnostics very useful tools that will save installation and troubleshooting time.

Read these instructions all the way through before starting work to become familiar with the entire procedure.

### 3.2.1 Test Ground Continuity

Test all terminals for continuity to ground. If continuity is identified, remedy the problem before proceeding.

### 3.2.2 Remove Group System Fuses (if applicable)

Make sure supervisory control system supply fuses are removed.

### 3.2.3 Remove Primary Controller Fuses

Remove fuses F4, F7, F8, to disable primary controller relay voltage, and the door operator. Place controller INSP and TEST switches in inspection and test positions, respectively (on).



**NOTE:** Always review prints to double check fuse designations and correct amperages.

### 3.2.4 Check Disconnect Switch

Check the line side of the disconnect switch and verify that all three legs are at the correct voltage.



**CAUTION:** Remove all protective covering on PC boards and components before applying power.

### 3.2.5 Turn on Disconnect

Turn on disconnect switch and check voltages at L1, L2, and L3 on starter(s).



**NOTE:** For Prodigy controllers the Starter unit and power terminals are located behind the front the panel, on the auxiliary power panel.

### 3.2.6 SH6 “Serial Safety” Jumper for Serial Link to Top of Car



**NOTE:** If serial link to Top of Car is not used, skip to next step.

Place SH6 jumper on the HLS-7 board, located in front of the JDRK2 harness connector, to allow safety string to be made without the TOC and COP boards being wired to the elevator system, thus permitting movement of the car on Inspection mode; Refer to page 3 area 3 of job prints for reference on jumper function, which is to bypass the circuit that makes sure the TOC and COP boards are in place.



**NOTE:** 3.2.7 is for Wye-Delta or Delta Motor Starter. Skip to Section 3.2.8 if using Solid State Starter.

### 3.2.7 Proper Pump Motor Rotation (Wye Delta or Delta Starter only)

Verify proper rotation of the pump motor by momentarily closing starter contacts (use the Y Contactor for Y-Delta starters). Do not hold for more than one second). If rotation is incorrect, interchange two of the leads at disconnect, or the top of the starter (**power lines only, not motor leads**).

#### 3.2.7.1 Reverse Phase Relay (Wye Delta or Delta Starter only)

Observe the RP (Reverse Phase) relay. If it is picked, proceed to the next step. If RP is not picked, check fuses F1, F2, and F3 and make sure that, if an adjustable sensor is provided, that the setting is correct.

If this does not cause the RP relay to pick, turn off the power and reverse two of the three wires (probably #14-#18 gauge) that feed 3-phase AC power from the starter to the rest of the controller (these wires will typically be at the top of the starter). Restore power. The RP relay should pick. If not, replace the RP plug-in sensor or the RP relay and repeat this step.



**NOTE:** Section 3.2.8 is for Solid State Motor Starter. (Skip to Section 3.2.9 if using Wye-Delta or Delta Starter).



### **3.2.8 Review Instructions (Solid State Starter only)**

Read the manufacturer's solid-state starter unit (SSSU) application instructions and use for reference through this section. The ready light should come on when power is applied to the input side of the SSSU. If there is a phase loss the phase reverse indicator will come on. Verify that the line-to-line voltage is the proper value. If incorrect, swap any two power input lines to the starter. This should correct the problem and the ready LED indicator should come on. Refer to SSSU manufacturer's manual for advanced troubleshooting.

#### **3.2.8.1 Proper Pump Motor Rotation (Solid State Starter only)**

Verify proper rotation of the pump motor by momentarily jumpering the enable contacts (Motor Run Input) on the SSSU. If motor rotation is reversed, correct by swapping two of the motor winding connections (refer to the SSSU manufacturer manual for directions to properly swap two of the motor winding connections).

### **3.2.9 Power Off**

Make sure power is turned off and replace the F4 fuse to restore relay voltage to normal.





**CAUTION:** Do not insert door fuses at this time.

### **3.2.10 Verify Safety Switches**

Verify car, car-top stop and any other safety switches making sure they are operating properly. In order for the elevator safety monitoring system to permit movement of the elevator, the following conditions must be met:

1. If roped hydraulic unit with governor switch: governor contact must be wired from terminals 4A to GOV. If no governor used, the SH33 jumper must be in place.
2. Verify the emergency stop switch between terminals 4A and 17, and the safeties between terminals 17 and 24. Please refer to job prints page 3.
3. If a submersible overload is provided, wire it between terminals 4 and SOL. If no submersible overload is used, jumper from 4 to SOL.
4. Verify that the UP (terminals 28 to 30) and DOWN (terminals 29 to 33) normal limits are made.
5. The car gate (Terminals 4 and CG) must be made, as well as the hoistway door safety string, bottom, Top, and Intermediate door locks between Terminals 4S and THD, refer to job prints to verify door lock wiring.
6. The Door Open Limit (Terminals 4 and DOLF) must be closed, and the Door Close Limit (Terminals 4 and DCLF) must be opened. If equipped with selective rear doors, the rear Car Gate and Door Open and Close limits must follow the same status as the front.
7. If the controller is equipped with the Ez-LINK serial communication option, install the SH6 "SERIAL LINK" jumper on HLS-7 to enable safeties to set without the COP and TOC boards being installed.

 **NOTE:** Circuits above will allow the car to move on Car Top Inspection mode of operation.

 **NOTE:** In order to allow the car to be run on Controller Inspection, car top inspection, in-car inspection, and Access mode switches must be in the off position. Car Top Inspection (4 to ICTO), In Car Inspection (ICTO to ICIO), Access (INAC to INAO), and Hall & Car Door Bypass switches in controller must be on normal position.

 **NOTE:** If elevator installation does not require In Car Inspection or In Car Access, jumper the respective terminals above to permanently disable these functions.

### **3.2.11 Temporary Final Limit Jumper**

If the car is at the top of the hoistway, jumper final limit terminals 23 to 24 to allow the car to move in the down direction.

 **CAUTION:** Remove this jumper as soon as it is possible to do so.

Use the UP/DN rocker switch if provided (the elevator safety code disallows this switch in some jurisdictions) on the controller to run the car. Refer to the valve manufacturer's adjustment instructions to adjust the low speed valves. The pump motor should start when running the car up.

For WYE-DELTA starters, the proper transition time from Wye to Delta should be checked at this time. Verify the Wye to Delta transition time and adjust the timer as required for smooth transition. The Wye to Delta timer is located under the System Timers Menu display. The default value is 2 seconds. Refer to the H900 Prodigy & Standard Field Reprogramming Manual for directions on how to use onboard diagnostics to modify parameters.

If no relays are picked, check fuse F4 and verify that 110 VDC, plus or minus 10%, is present between terminals 3 and 4A. This voltage should also be found on terminal 4. If voltage is present on terminal 4A but not on terminal 4, turn to page 3 of the prints (area 3) and re-verify Emergency Stop and Elevator Safeties wiring.

If Solid State Starter Unit or Variable Voltage Variable Frequency starter is provided, refer to the manufacturer's manual for acceleration and up-to- speed motor control adjustment.

### **3.2.12 Run the Car**

Use the controller UP/DN switch to run the car.

 **NOTE:** The controller INSPECTION switch must be in ON position. The car top inspection switch, and other switches must be on normal for the up/dn switch to operate.

### **3.2.13 Startup is Complete**

The elevator installation should now be completed including installation of the selector, etc.

# Section 4 – Adjustment

## 4.1 Final Adjustment of the Elevator Controls H900 Controller

### 4.1.1 Door Adjustment

The elevator should be shut down and main power shut off.

- a. Install door fuses F7 and F8.
- b. Position the car in the hoistway so that car doors can be adjusted to a preliminary setting within the door zone area.
- c. Open the doors by jumpering the non-banded side of diode D73 (under the DO relay) to terminal 3 on the controller and close doors by jumpering the non-banded side of diode D65 under the DC relay to terminal 3, or place the car on inspection and follow door operation adjustment procedure described by the door operator manufacturer.



**NOTE:** Most new solid-state door control systems offer adjustment procedures that require no interaction with the elevator controller.

### 4.2 Check Hoistway Clearances

The door operator must be operating properly with all door equipment clutches, rollers, etc., adjusted to correct running clearances. Make sure all hoistway and car doors in the building are closed and locked. Run the car on inspection the entire length of the hoistway to be sure that the hoistway is completely clear of obstructions. Check to be sure that all selector vanes and the tape selector unit are properly installed per manufacturer's instructions.

### 4.3 Use of Test Switch

Turn the TEST switch to "Test" position, (the TEST switch is located on the HLS-7 board). Placing this switch in the test position prevents the controller from opening the doors (both front and rear if the car has rear doors) while car behaves as on Independent Service mode of operation.

Verify that all ribbon cable connectors, harness connectors, and relays are seated properly. Turn on AC power. Switch from inspection to normal operation. The car should travel to the bottom terminal landing, or re-position itself to the correct landing.



**NOTE:** If this does not happen, jumper terminal 4 to DCB (door close button), place the control test switch in the "TEST" position. Observe the LCD liquid crystal display for Error Condition to determine why the elevator is not responding. Pay particular attention to the multiple LED indicators on the I/O-7 or PIO9, board.

If the car is leveling, the LVLM indicator will be off, and the car will not be able to respond until the leveling process is complete. If any of the door opening devices or any call input is active, the corresponding indicator will be lit. If the SD (or SU for up) indicator is on and the Down relay is not picked, check the normal limit switch. Also, check DSD2 and USD2 LED's. They must not both be off, or reversed, as these are the terminal floors slowdown switches that open when the car is at the corresponding terminal landing.

Refer to Troubleshooting Section 5 of this manual for guidance.

## 4.4 Ez-LINK Serial Communication System Verification



**CAUTION:** Make sure the Serial Safety jumper has been removed from SH6 post terminals on HLS-7 board, if job is equipped with Ez-Link to top of car.



**NOTE:** For non Ez-LINK systems, skip to Section 4.1.5.

### 4.4.1 Verify Communication to TOC Board

To verify communication to the top of the car, LED's DIAG1 and DIAG2, on the TOC board should be blinking (approximately 4 times a second). DIAG2 indicates communication with the P8X or PIO9, board in the controller, and DIAG1 indicates communication with COP board (or boards if rear doors are present). If the two diagnostic LED's are not blinking 4 times a second, verify wiring, and shielded communications wiring connections. Also, make sure all shields are jumpered on all hoistway junction terminal strips.

### 4.4.2 Verify Communication to COP Board

To verify communication to the COP board, LED's TOC, COP and PC, on the COP board, should be blinking (approximately 4 times a second). LED1 and LED2 indicate communication with the TOC board on top of the elevator cab. If the two diagnostic LED's are not blinking 4 times a second, verify wiring. Perform this same check for the rear COP board, if present.

### 4.4.3 Verify Communication from COP to TOC Boards

Verify all signals coming from the COP and TOC boards to the P8 or PIO9, elevator microprocessor board. Refer to the Field Reprogramming Manual "Direct Access" menu. To view the following table, have someone go inside the elevator cab and press each car call and activate each button, while a second person selects and verifies proper activation response in the P8 or PIO9, memory map below:



**NOTE:** Verify that all job-required signals activate the proper input memory location in the P8 or PIO9, computer, per the table below, before removing the car from Inspection operation. Table Fig 4.1 lists all possible signals. You need only verify signals pertaining to your specific system.

To verify communications to the top of the car, LED's DIAG1 and DIAG2, on the TOC board should be blinking approximately 4 times a second. DIAG2 shows communications with the P8X or PIO9, board in the controller, and DIAG1 shows communications with COP board or boards if front and rear doors are present. If any of the two diagnostics LED's are not blinking approximately 4 times a second verify wiring and communications shield wiring connections, make sure all shields were jumpered through out all hoistway junction terminal strips.

**Figure 4.1 – Ez-LINK Memory Input Map**

Address	Bit 7	Bit 6	Bit 5	Bit 4	Bit 3	Bit 2	Bit 1	Bit 0	
F900	U8R	U7R	U6R	U5R	U4R	U3R	U2R	U1R	UCIR: Up call input rear
F901	U16R	U15R	U14R	U13R	U12R	U11R	U10R	U9R	
F902	U24R	U23R	U22R	U21R	U20R	U19R	U18R	U17R	
F903	U32R	U31R	U30R	U29R	U28R	U27R	U26R	U25R	
F904	U40R	U39R	U38R	U37R	U36R	U35R	U34R	U33R	
F905	U48R	U47R	U46R	U45R	U44R	U43R	U42R	U41R	
F906	U56R	U55R	U54R	U53R	U52R	U51R	U50R	U49R	
F907	U64R	U63R	U62R	U61R	U60R	U59R	U58R	U57R	
F908	D8R	D7R	D6R	D5R	D4R	D3R	D2R	D1R	DCIR: Down call input rear
F909	D16R	D15R	D14R	D13R	D12R	D11R	D10R	D9R	
F90A	D24R	D23R	D22R	D21R	D20R	D19R	D18R	D17R	
F90B	D32R	D31R	D30R	D29R	D28R	D27R	D26R	D25R	
F90C	D40R	D39R	D38R	D37R	D36R	D35R	D34R	D33R	
F90D	D48R	D47R	D46R	D45R	D44R	D43R	D42R	D41R	
F90E	D56R	D55R	D54R	D53R	D52R	D51R	D50R	D49R	
F90F	D64R	D63R	D62R	D61R	D60R	D59R	D58R	D57R	
F910	U8F	U7F	U6F	U5F	U4F	U3F	U2F	U1F	UCIF: Up call input front
F911	U16F	U15F	U14F	U13F	U12F	U11F	U10F	U9F	
F912	U24F	U23F	U22F	U21F	U20F	U19F	U18	U17F	
F913	U32F	U31F	U30F	U29F	U28F	U27F	U26F	U25F	
F914	U40F	U39F	U38F	U37F	U36F	U35F	U34F	U33F	
F915	U48F	U47F	U46F	U45F	U44F	U43F	U42F	U41F	
F916	U56F	U55F	U54F	U53F	U52F	U51F	U50F	U49F	
F917	U64F	U63F	U62F	U61F	U60F	U59F	U58F	U57F	
F918	D8F	D7F	D6F	D5F	D4F	D3F	D2F	D1F	DCIF: Down call input front
F919	D16F	D15F	D14F	D13F	D12F	D11F	D10F	D9F	
F91A	D24F	D23F	D22F	D21F	D20F	D19F	D18F	D17F	
F91B	D32F	D31F	D30F	D29F	D28F	D27F	D26F	D25F	
F91C	D40F	D39F	D38F	D37F	D36F	D35F	D34F	D33F	
F91D	D48F	D47F	D46F	D45F	D44F	D43F	D42F	D41F	
F91E	D56F	D55F	D54F	D53F	D52F	D51F	D50F	D49F	
F91F	D64F	D63F	D62F	D61F	D60F	D59F	D58F	D57F	
F920	DOLF	DBCf	DOBF	LLI	SEF	PHEF	DHLDF	DCLF	Front door inputs
F921	DOLR	DBCR	DOBR	DHLDR	HLI	SER	PHER	DCLR	Rear Door Inputs
F922	FCS	CLLI	IND	PGI	CCI	copRc	copFc	tocC	Fire and Misc. inputs
F923	RD	PR	R32	R16	R8	R4	R2	R1	Absolute floor position
F924	Analog load weigher 16 bit value (future)								Used if analog load weighing device is used
F925									
F926	CF8	CF7	CF6	CF5	CF4	CF3	CF2	CF1	Car calls front floors 1 to 8
F927	CR8	CR7	CR6	CR5	CR4	CR3	CR2	CR1	Car calls rear floors 1 to 8
F928	FREE	FREE	FREE	p8xC	hallC	auxlr	auxlf	emtP2in	
F929	C16F	C15F	C14F	C13F	C12F	C11F	C10F	C9F	ACCIF: Front car call input
F92A	C24F	C23F	C22F	C21F	C20F	C19F	C18F	C17F	
F92B	C32F	C31F	C30F	C29F	C28F	C27F	C26F	C25F	
F92C	C40F	C39F	C38F	C37F	C36F	C35F	C34F	C33F	
F92D	C48F	C47F	C46F	C45F	C44F	C43F	C42F	C41F	
F92E	C56F	C55F	C54F	C53F	C52F	C51F	C50F	C49F	
F92F	C64F	C63F	C62F	C61F	C60F	C59F	C58F	C57F	
F930	C16R	C15R	C14R	C13R	C12R	C11R	C10R	C9R	
F931	C24R	C23R	C22R	C21R	C20R	C19R	C18R	C17R	

Ez-LINK Memory Input Map Continues									
F932	C32R	C31R	C30R	C29R	C28R	C27R	C26R	C25R	
F933	C40R	C39R	C38R	C37R	C36R	C35R	C34R	C33R	
F934	C48R	C47R	C46R	C45R	C44R	C43R	C42R	C41R	
F935	C56R	C55R	C54R	C53R	C52R	C51R	C50R	C49R	
F936	C64R	C63R	C62R	C61R	C60R	C59R	C58R	C57R	
F937	FREE	FREE	FREE	FREE	FREE	ATT	UP	DN	Attendant inputs

## 4.5 Running the Car on Test Mode

 **NOTE:** When the test switch on the HLS board (located on the relay printed circuit board) is in the "ON" position, the doors will not open when the car arrives at a floor.

 **NOTE:** To place car calls from the machine room for a standard non Ez-LINK systems, jumper from the IO-7 Call GND post, located on the top right corner of the board, to the car call field terminals on the IO-7 or IO-EX boards for standard controllers or from Terminal 3 to the car call field terminals on the PIO9 or IO-EX boards for Prodigy controllers.

 P8 or PIO9 with car program version V5.50 or latter, use the Reprogramming Manual to locate the car call entry menu by raising all four menu switches and pressing the **UP** or **DN** (down) buttons to display **System Control**. Lower the Menu / Sub switch to enter the System Control menu and press the **UP** button until **EZ Link Advance** is displayed. Lower the View / Edit switch to enter direction and floor data.

### Procedure

- Place the car on test mode.
- Set the left LCD character to 1 to move the car up or 0 to move the car down by pressing the **UP** or **DN** buttons.
- Press the shift button **SHIFT** to move between characters.
- Set the right LCD character to the number of floors from the current position to move the car by pressing the **UP** or **DN** buttons. A valid floor offset entry is 1 to 9 where 1 will command a 1 floor run, and 3 will command a 3 floor run, etc.
- Press the write button **WR** to start. Keep pressing the write button each time the car arrives at a floor to continue moving the car up or down by the same number of floors.

If a car traveling in either direction fails to reach the call within a pre-determined interval, the controller will identify this occurrence as a fault condition and automatically stop the car. Further operation of the elevator will be prevented until the fault condition has been cleared. To reset this fault, momentarily place the car on Inspection mode.

## 4.6 Landing System Selector

Verify placement and operation of selector magnets or vanes and switches in the hoistway for proper stepping. Adjust valves for proper operation, verify the operation of all call buttons, and verify all functions including fire service main, alternate, and phase 2; independent service, access operation, etc. and verify car and door devices and switches; terminal slowdown, Up and Down normal limit switches, and all safety switches. Verify proper floor leveling and correct any problems.

## 4.7 Soft Stop Timer Control

Regulation of the pump motor for the up direction is controlled by relay outputs AA/MGR and BB-BH driving the pilot relays AA and BH (see prints). When these relays are energized, and the car is in the door zone area completing an up run, the computer will hold AA/MGR and BB-BH outputs, (as indicated by the LED indicators on the I/O-7 or PIO9 board) for a predetermined field adjustable time. If it becomes necessary to adjust this timer, please refer to the Field Reprogramming Manual re: use of onboard diagnostics for complete details. This manual also includes instructions for accessing the "wealth" of information available through use of the onboard diagnostics provided.

## 4.8 Motor Limit Timer Control

If the car is traveling in the up direction and fails to reach the call within a pre-determined time interval, the controller will identify this occurrence as a fault condition. The controller will automatically stop the pump and motor and return the car to the lowest landing.

After the doors are opened, further operation of the elevator will be prevented until the fault condition has been cleared. To reset this fault, cycle the inspection switch, or power disconnect.

The computer error code LED indicators and LCD will display the corresponding error status. This timer is factory preset for 180 seconds. Refer to the Field Reprogramming Manual for instructions on adjusting this timer.

## 4.9 Multiple Door Open Times

The H900 controller is equipped with selective door timing for car, hall, and short door open times. The factory-preset values are field-adjustable through the use of the onboard diagnostics unit. Refer to the Field Reprogramming Manual for complete details. Check door open times for proper operation conforming to ADA and other applicable codes.



**NOTE:** The hall door timer starts as soon as the car engages DZ, even if it is still leveling. If the pre-opening option is not set, the doors may not finish opening before the hall door timer expires. If this happens because the car takes too long to finish leveling into the floor, extend the hall door timer value to account for the extra leveling time.

# Section 5 – Troubleshooting

## 5.1 System Not Functional in General (Car Won't Run)



**NOTE:** The Solid State portion of the Elevator Controls Microprocessor Controller is the most reliable part of the entire elevator system. While it is possible that a problem may occur, one should first look to the power controller and "outside world" for the malfunctions that most frequently take elevators out of service.

### 5.1.1 General Troubleshooting Tips

For your convenience, and to save troubleshooting time, the H900 controller is equipped with multiple indicators that are designed to help you troubleshoot at a glance.

You are strongly advised to pay particular attention to the indicators on the I/O-7 or PIO9 board. Every action instructed by the computer is indicated (DOF for example means door open function, the computer wants to open doors), and every action the human interface wants the computer to perform is also indicated (DOB for example means the door open button is active).



**NOTE:** Signal names written with bar on top of the signal name indicates the signal is in active mode when the LED is off ( $\overline{\text{FRS}}$  and  $\overline{\text{FRA}}$  are a good examples – when the LED is off they indicate the car is on main or alternate fire mode respectively).

The computer error code LED display will flash a particular status/error code as detected by the P8 or PIO9 computer; a list of these codes can be found permanently applied to the inside of the controller door. Extra or replacement copies can be made from the list found in the Field Reprogramming Manual.

Computer error/status codes are also displayed in English format on the LCD display. Finally, an optional PC may be used for powerful troubleshooting, diagnostics, and for monitoring purposes.

### 5.1.2 Car Not Running General Check List

- a. Make sure that the car is not on Fire Emergency Service; The P8 or PIO9 will display the fire operation active if any. During normal operation of fire emergency circuits, 24-110V should be present on each fire recall terminal with respect to terminal 3, (refer to prints page 6 for fire interface circuits).
- b. If all terminals for Fire Emergency Service are properly set, refer to Section 5.2.1 for directions to reset the different modes of Fire Emergency Service.
- c. If the elevator is not set to Fire Emergency Service, all power supplies should then be checked. The natural starting point is the three-phase input. There must be 208-480 VAC (as specified) present between all combinations of phases.



- d. Verify that each power control step-down transformer has the correct secondary voltage (refer to Controller Schematic page 1 for terminal and fuse numbers). Replace fuses as necessary.
- e. The RP (Reverse Phase) Relay must be latched. If it is not:
  - (1) Check the fuses supplying power the RP Module.
  - (2) Replace the RP Relay with the correct type specified.
- f. After verifying the operation of the RP Relay, the local controller power supplies should be verified. First, Terminal 4A should measure approximately +110 VDC. The voltage at Terminal 50, (hall lamp supply) with reference to ground and the voltage between Terminal Strip terminals AC1 and AC2 should be measured and verified to be in accordance with the voltages shown on page 1 of the job prints. If any of the above power supply voltages are not within range, check the appropriate fuses.



**NOTE:** System common is terminal 3, (normally terminal 3 is connected to chassis ground) unless otherwise noted, all DC voltage measurements are shown with respect to Terminal 3, or chassis ground.

- g. Verify the Safety String (schematic for it is located on the upper portion of page 3 of the job prints). The Safety String is made up of normally closed safety contacts and switches connecting Terminal 4A to Terminal 24. In order for the car to run, all of these contacts must be closed, which will cause +110 VDC to be applied to Terminal 24 (for Hydraulic controls, system terminal 24 is connected to terminal 4) signaling the computer input that the safety string is closed (SAF input is active, verify LED on IO-7 or PIO9).
- h. Assuming Terminal 4 is operating properly at +110 VDC; verify that the computer display does not show Safety String Open. If this message is displayed, check to be sure that the termination jumper plug has been correctly placed on the last IO-7, IO-EX or PIO9 board inside the Out ribbon cable connector.
- i. Verifying that the GTS indicator located on the IO-7 or PIO9 is on, the following relays should also be on: GTS, GTSX, STOP, (STOP will be on for Automatic mode of operation and off for Inspection/ Access operation) CG, and once demand is establish, U or D (depending on intended direction). AA should be on, H relay will also pick if the slowdown for that direction of travel is closed and automatic mode of operation is selected.



**NOTE:** All relays mentioned above on item “i” are located on the HLS-7 board.

- j. Direction (SU/SD) and speed signal HR both enter the HLS-7 board from the computer relay driver outputs on the I/O-7 or PIO9 board via the connecting ribbon cable. Pin numbers are indicated on prints (pin one is indicated by a red conductor in the ribbon cable). If a high speed run toward a call is required, register a call and check the appropriate up or down arrow (SUA/SDA) LED. If neither arrow is on, make sure no special function has control of the car (INS-STOP in), and that the fire warning indicator (FWI) is off. If all the above functions are normal, call registration should establish a direction of travel as indicated by an arrow, which can be observed

on the IO-7 top right corner or towards bottom left corner on the PIO9 LED indicator. If no arrow is displayed, refer to the Microprocessor Troubleshooting Section 5.6 following below.

- k. Some of the relay coils referenced above are hardware interlocked through the door safety circuit. In order for the car to move away from a landing, all doors must be closed and locked. A locked condition is indicated by a lit DLK indicator on the I/O-7 or PIO9 board (+110 VDC on Terminal 11). An unlocked condition leaves the DLK indicator unlit (with 0 VDC on Terminal 11). Also the door closed limit switch should be open and the door open limit should be made, (verify 0 volts on terminal DCLF and +110 VDC on terminal DOLF). If the door string indicates an unlocked condition, examine and repair door locks as required.
- l. Should the U or D relays remain unlatched with a properly locked door circuit, check the UP STOP LIMIT switch located between terminals 28 to 30, similarly terminals 29 to 33 for down. These switches are feeding power to the directional circuits. If switches are not made, the direction relays can not be energized by the microprocessor outputs. See page 3, area 4 and 5 of prints for stop limit switches and directional circuit functions.

## 5.2 Microprocessor Error Reporting and Correction

### 5.2.1 Elevator Normal Operation and Fault Monitoring & Display

The tables below list the various faults that can be generated from the normal monitoring portion of the system as follows:

**Scrolling Message:** Indicates the display shown on the LCD display for each fault.

**Description and Possible Solution:** Explains how the fault was generated and possible corrective action to resolve the fault.

 **NOTE:** Faults listed in Figure 5.1 below will not prevent the car from starting or executing the function fault such as Fire Service, Independent Service, Etc. Faults listed in Figure 5.2 will prevent the car from running.

 **NOTE:** A group of special conditions are recognized by the microprocessor. If one of these "errors" occurs, a code will be displayed corresponding to that condition. The microprocessor will scroll up to 6 errors at a time on the LCD display. The eight LED array will display the error that needs too be corrected first, that is, the one with the highest priority.

 **NOTE:** The field technician should look first to the LED array to identify the error that needs to be corrected first. Error codes can be found in this Section (below) and on the inside of the control equipment enclosure door.

**Figure 5.1 – Fault Conditions that will Not Prevent the Car from Running**

Scrolling Message	Description and Possible Solution
Main Fire Service Phase 1	Main floor smoke detectors or HF1 smoke detectors activated. Reset smoke detectors. <b>Return car to the fire floor and turn fire service switch to reset to clear fire service condition.</b>
Alternate Fire Service Phase 1	Alternate floor smoke detectors or HF2 smoke detectors activated. <b>Reset smoke detectors. Return car to the fire floor and turn fire service switch to reset to clear fire service condition.</b>
Fire Service Phase 2	Fire Service Phase II switch is on or was on before power down. <b>Return car to the fire floor and turn Fire Service Phase II switch to off position and open the doors to break door open limit to clear fire service condition.</b>
Front Doors Not Fully Closed	Front door closed limit not open, even do door lock is made.
Rear Doors Not Fully Closed	Rear door closed limit not open, even do door lock is made.
Leveling Down	Level Down input on
Leveling Up	Level Up input on
In leveling Zone Without Direction	Either level Up or Down input is active but direction of movement can't be achieved. <b>Verify Up and Down terminal switches probably one or both are open.</b>
Re-Leveling Down	Re-Leveling Down on after being level
Re-Leveling Up	Re-Leveling Up on after being level
Trying to Re-Level Without Direction, or Both Directions On	Either level Up or Down input become active after being level, but direction of movement can't be achieved. <b>Verify Up and Down terminal switches probably one or both are open.</b>
Doors Unlocked	Car at landing with the doors not locked, DLK input off.
Security mode in operation	BSI input is active, placing car in COP security operation, where the COP car call buttons are used to input access codes to place car calls.
Independent Service	IND input is active, placing car in independent mode of operation.
Hospital Service	Car is responding to a hospital emergency request.
Emergency power operation	Car is executing an emergency power return or operating under emergency power.

## Fault Conditions that will Not Prevent the Car from Running (continued)

EMT phase 1 operation	EMT-1 input became active to request Massachusetts's Medical emergency recall.
EMT phase 2 operation	EMT-2 input became active to place the car on Mass. Medical emergency mode of operation.
Earthquake: Normal condition	EQI input become active and then went back to normal allowing the car to run on earthquake normal mode at 150ft/min maximum speed.
Earthquake: Abnormal condition	EQI and CWI inputs became active and stayed active, counter-weight derailed grounding both inputs, or CWI input is active only indicating that the string running in the hoistway tear down.
Heavy Load in Car	HLI input became active, placing car under heavy load operation thus bypassing hall calls until doors open and HLI input becomes in-active.
Controller Inspection	Car is under controller inspection mode of operation.
Access Inspection	Car is under access inspection mode of operation.
In-car inspection	Car is under in car inspection mode of operation.
Ca top inspection	Car is under car top inspection mode of operation.
Viscosity Control	The microprocessor is running the pump motor while the VSI input is on to keep the motor oil viscosity under control. The pump will run for three minutes on and stop for nine minutes, and will continue this cycle until VSI input becomes inactive.
Car on wild operation	Group - loss of communication or WILD operation is active. Function can be used for Sabbath operation.
Car door bounced during takeoff	The car took off on high speed run and the doors relaxed, opening the door lock safety string to terminal 11. <b>Make sure door close power while running shunt jumper Sh21 on HLS board has been installed, where applicable, verify page 3 of prints and your door operator manufacturer for proper guidance.</b>
Door lock clipped open at high speed	The car was running on high speed while the door lock broke open. <b>Check door lock clearance.</b>
Hall or car lamp fuse blown	The computer is detecting all car or all hall call buttons active at the same time, which happens when the common to the lamps is not present. <b>Check fuses FLS or 50H, 50. Refer to page 1 of prints.</b>

## Fault Conditions that will Not Prevent the Car from Running (continued)

Absolute PI correction	The computer internal selector track did not match the absolute floor encoding in the hoistway for the floor the car just arrived. <b>Remove RD signal and run the car with the internal selector tracking only, if car does not stop at the wrong landing verify the position feedback portion of the selector. If the car stops at the wrong floor verify the stepping portion of the selector.</b>
Door zone count error	Error display will occur when stepper tracking option is set to on, and is used to determine which selector signal may be missing in the hoistway causing the car to stop at the wrong floors. <b>Call Elevator Controls for more information about using this option for diagnostics.</b>
Door Zone Input Error	The car got the door zone input before engaging leveling, i.e. crash into a floor. Once error occurs it latches until microprocessor is reset or the car is momentarily placed on inspection to clear fault message. <b>Verify LU and LD work properly at each floor.</b>
Car out of Step	Missed door zone input or mechanical speed limit actuated before selector stepping input. This error is only detected while the car approaches a terminal landing. Once it occurs, it latches until the microprocessor is reset or the car is momentarily placed on inspection to clear fault message. <b>Correct position of Up and Down slowdown switches, need to activate 1 to 2 inches after STU or STD drop off. Verify and replace any DZ target on the selector if needed.</b>
Test mode	Test switch on, car will behave as in independent service but will inhibit door opening operation.
Unknown Error	The computer detected an error that was not able to identify. <b>Place car on inspection, and reset the microprocessor. Call Elevator Controls if error persists.</b>
Password access active	Current password has been entered and system access granted.

**Figure 5.2 – Fault Conditions that Will Prevent the Car from Running**

Scrolling Message	Description and Possible Solution
Safety String Open	Voltage is not getting to the microprocessor SAF input. <b>Check voltage on terminal 4A (110 VDC), and follow the safety string path to terminal 24. Refer to page 3 of job prints.</b>
USD2 & DSD2 on simultaneously	Both Up and Down Slowdown speed limits switches are open at same time. <b>One of the two or both limit switches failed repair or replace.</b>
Check channel A cable / termination	A cable on Channel A chain is not properly seated or the last board on the chain does not have the terminator jumper installed. <b>Re-seat cables, or add terminator to last IO board.</b>
Check channel B cable / termination	A cable on Channel B chain is not properly seated or the last board on the chain does not have the terminator jumper installed. <b>Re-seat cables, or add terminator to last IO board, only for P8 driven controllers.</b>
EEPROM write failure	The computer was not able to write to the electrically erasable EEPROM. <b>Replace EEPROM U-18. U-18 contains the personality portion of this elevator, replacing this chip will mean that all field modified parameters will need to be re-entered, or notify Elevator Controls so that they can be incorporated with new chip.</b>
Door open limit & door lock on simultaneously	Door lock input is active and, door open limit (DOL or DOLR) is open. One of the two inputs is incorrect if the doors are fully closed the DOL limit is bad, and if fully open the door lock is bad. <b>Correct either door open limit or door lock switches.</b>
Starter stuck in Wye or bad starter output	No DEL input or feedback is being received and the Delta output has been activated. <b>Bad delta contactor or auxiliary contact, or bad IO-7 or PIO9 output or input.</b>
Door reopen input active	The door open button or safety edge is still active and the doors are already fully open.
DCL: Doors not closed	Door lock is made but door closed limit still closed. <b>Re-position DCL switch as to open while the doors lock.</b>
Motor run stall protection timer expired	The car did not reach destination during the time allowed to be with the pump motor on. This problem occurs if car can not level into a floor due to malfunction of valves, or the Motor limit timer is too short for the distance required to travel. <b>Verify Motor stall protection Timer, refer to the Field Reprogramming Manual, and make sure car is capable leveling at every landing especially terminal landings without opening the normal terminal switches.</b>

## 5.2.2 ASME-A17.1A Monitoring

The table below shows the different faults that can be generated by the ASME-A17.1A monitoring portion of the system as follows:

- Message: Indicates the display shown on the LCD display for each fault.
- Output: The response of the system by dropping the Stop relay only, or Stop and GTS-GTSX combination, depending on the severity of the fault.
- Reset Required Yes: indicates that in order for the car to return to normal the fault generating problem has to be resolved and the ANSI-Rest push button has to be pressed to clear the fault. Reset Required No: will allow the car to return to normal operation as soon as the problem that caused the fault is resolved.
- Conditions Producing Monitor Fault: Indicate the input and output flags that are involved to generate such faults.
- Description and Possible Solution: Explains how the fault was generated and what may be a corrective action to resolve fault.
- Address of Bit in Memory: Indicates where in memory the computer stores the state of the monitored points. Please refer to the Field Reprogramming Manual to see how to access these memory locations.

**Fig 7.4 ASME-17.1A Monitor Errors**

Message	Output	Reset Required	Conditions Producing Fault	Description and Possible Solution	Bit Memory Address
Contact drop system fault <b>Note: Fault active also on Non- ANSI-2000 Controllers</b>	Won't run until fault clears	No	MGR = 1 STPM = 1 Or MGR = 0 STPM = 0	Contact relay output is on and monitoring input is on. <b>Bad contact on AA, BK, H, or contactor auxiliary, see page 3 of job prints for reference.</b>	F007 bit 7 F1C2 bit 5
GTS relay fault	Reset inStop and gtsOut	Yes	GtsOut = 0 GTSM = 0 Or GtsOut = 1 GTSM = 1	GTS relay output and GTSM monitoring contact is active. <b>GTS or GTSX or both relays are bad.</b>	F1CE bit 0 F1C2 bit 0
Stop relay fault	Reset inStop	No	HDBM = 1 INS-STOP= 1 STOPM = 1	Door lock bypass is off, INS-STOP output is on and STOPM monitoring contact is active. <b>Bad STOP relay.</b>	F1C2 bit 6 F1CE bit 5 F1C2 bit 3
Front door limit system fault	Won't run until fault clears.	No	DCLF = 0 DOLF = 0	Door open limit front and door closed limit front are both open. <b>Bad IO or PIO9 board or field problem.</b>	F006 bit 0 F000 bit 7

### ASME-17.1A Monitor Errors (continued)

Rear door limit system fault	Won't run until fault clears.	No	DCLR = 0 DOLR = 0	Door open limit rear and door closed limit rear are both open. <b>Bad IO or PIO9 board or field problem.</b>	F006 bit 1 F005 bit 7
Door zone relay fault	Won't run until fault clears.	No	DZORDZ = 0 DZM = 0	Door zone input is not active and DZM relay monitoring contact is also not active. <b>Bad DZ relay.</b>	F01A bit 0 F37F bit 2
Door zone relay fault	Won't run until fault clears.	No	DZORDZ = 1 DZM = 1	Door zone input is active and DZM relay monitoring contact is also active. <b>Bad DZ relay.</b>	F01A bit 0 F1C2 bit 2
Door lock relays fault	Won't run until fault clears.	No	CGF = 1 DLM=1 Or CGR=1 DLM=1	Car gate CG Front or CG Rear, and Hoistway door locks are open but monitoring input DLM is not active. <b>Bad CG relay.</b>	F1C2 bit 7 F1C3 bit 0  F1C3 bit 5 F1C3 bit 0
Door lock relay fault	Won't run until fault clears.	No	CGF = 0 CGR = 0 HDR=0 DLM=0	Car gates inputs are active and CG monitoring contact is also active. <b>Bad CG relay or HDR relay, or both relays are bad.</b>	F1C2 bit 7 F1C3 bit 5 F1C3 bit 4 F1C3 bit 0
Level relay fault	Won't run until fault clears.	No	lvlOut = 1 LU = 1 LVLM = 1	Car is allowed to level into a floor LU input is active and LVLM monitoring input is active. <b>Bad LVL relay.</b>	F1CD bit 0 F01C bit 7 F001 bit 1
Level relay fault	Won't run until fault clears.	No	lvlOut = 1 LD = 1 LVLM = 1	Car is allowed to level into a floor LD input is active and LVLM monitoring input is active. <b>Bad LVL relay.</b>	F1CD bit 0 F01C bit 6 F001 bit 1
Bypass system fault	Won't run until fault clears.	No	INS = 1 HDBM = 1	Inspection input not active inside memory, LED indicator on IO-7 or PIO9 On, and HDBM Switch monitoring input still active. <b>Bad IO-7, or PIO9 or bad HLS-7 bypass Switches.</b>	F001 bit 7 F1C2 bit 6
Door lock system fault	Won't run until fault clears.	No	IN = 0 CGF = 1 DOLF=0 DCLF=1 THD=0	Car not on inspection, front doors fully open, and car gate is closed. <b>Bad IO-7 or PIO9, or bad Door open limit front Switch.</b>	F001 bit 7 F1C2 bit 7 F000 bit 7 F006 bit 0 F1C3 bit 1



<b>ASME-17.1A Monitor Errors (continued)</b>					
Door lock system fault	Won't run until fault clears.	No	IN = 0 CGF= 0 DOLF=0 DCLF=1 THD=1	Car not on inspection, front doors fully open, and hoistway doors still closed. <b>Bad IO-7 or PIO9, or bad hoistway door lock Switch.</b>	F001 bit 7 F1C2 bit 7 F000 bit 7 F006 bit 0 F1C3 bit 1
Door lock system fault	Won't run until fault clears.	No	IN = 0 CGR= 1 DOLR=0 DCLR=1 HDR=0	Car not on inspection, rear doors fully open, and car gate is closed. <b>Bad IO-7 or PIO9, or bad Door open limit rear Switch.</b>	F000 bit 7 F1C2 bit 7 F005 bit 7 F006 bit 1 F1C3 bit 1
Door lock system fault	Won't run until fault clears.	No	IN = 0 CGR= 0 DOLR=0 DCLR=1 HDR=1	Car not on inspection, front doors fully open, and hoistway doors still closed. <b>Bad IO-7 or PIO9, or bad Door open limit Switch.</b>	F000 bit 7 F1C2 bit 7 F005 bit 7 F006 bit 1 F1C3 bit 1
Car stop bypass relay fault	Won't run until fault clears.	No	CSB = 0 CSBM = 0	CSB relay output is off, and CSB monitoring contact input is also off. <b>Bad CSB relay.</b>	F007 bit 6 F1C2 bit 4
Car stop bypass relay fault	Won't run until fault clears.	No	CSB = 1 CSBM = 1	CSB relay output is on, and CSB monitoring contact input is also on. <b>Bad CSB relay.</b>	F007 bit 6 F1C2 bit 4
Inspection switch fault	Won't run until fault clears.	No	InsACC = 1 or InsCT = 1 or	Main inspection input is off, and one of the inspection mode inputs is on. <b>Bad IO-7 or PIO9, or bad Inspection, car top or in-car, or Access switches bad.</b>	F01C bit 2 F01C bit 4
Inspection switch fault	Won't run until fault clears.	No	insINC = 1 INS = 0 insACC = 1 insCT = 1	Main inspection input is on, and access input and car top input on. <b>Bad Access switch.</b>	F01C bit 3 F001 bit 7 F01C bit 2 F01C bit 4
Inspection switch fault	Won't run until fault clears.	No	INS= 0 insACC = 1 insINC = 1	Main inspection input is on, and access input and in car input on. <b>Bad Access switch.</b>	F001 bit 7 F01C bit 2 F01C bit 3
Inspection switch fault	Won't run until fault clears.	No	IN = 1 insCT = 1	Main inspection input is on, and in car and car top input on. <b>Bad in car inspection switch.</b>	F001 bit 7 F01C bit 4

<b>ASME-17.1A Monitor Errors (continued)</b>					
Down Relay Fault <b>Note: Fault active also on Non-ANSI-2000 Controllers</b>	reset inStop and gtsOut	Yes	Hydro Option On SD=0 DNS=1	Computer Down input DNS, is active while down output SD, is off. <b>Bad Contact on D relay, Replace D Relay</b>	F003 bit 0 F007 bit 1 F001 bit 2
Unintended movement system fault <b>Car will stop immediately. Manual reset is required.</b>	reset inStop and gtsOut	Yes	INS = 1 DZORDZ = 0 THD = 0 CG=0	Car is not within door zone area, not on inspection mode, and the car gate and hoistway door lock string are open. <b>Correct door lock string, and car gate lock switches.</b> <b>Note: While releasing car from car top inspection there is a time-out period to allow the technician to close doors and release car before tripping occurs.</b>	F1C3 bit 1 F01A bit 0 F1C3 bit 1 F1C2 bit 7

### 5.2.3 ASME-A17.1a Fault Monitoring Flow Charts

The following section contains a series of flow charts showing the different scenarios that create an ASME-A17.1a monitoring fault. Flow chart analysis may aid understanding of system processes In order to resolve problems that may occur with the elevator control system.

Space intentionally left blank

### 5.2.3.1 Unintended Movement Flow Chart

The following flow chart shows the status and events that result in Unintended Movement Fault.

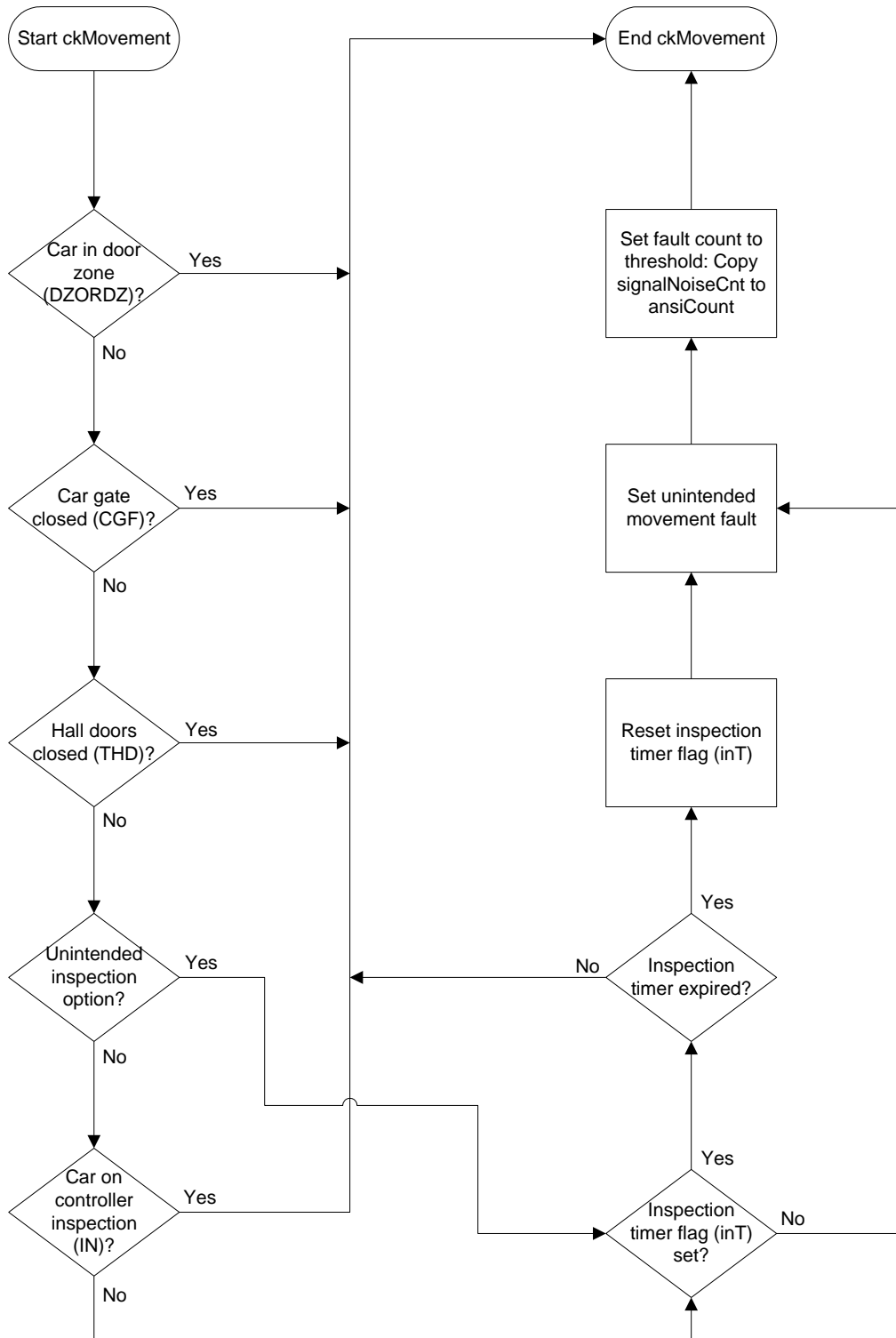

### 5.2.3.2 ASME-A17.1A Monitoring Analysis Input Fault Flow Chart

The following flow chart shows the fault-scan process for logging and responding when an ASME-A17.1A monitoring fault is detected.

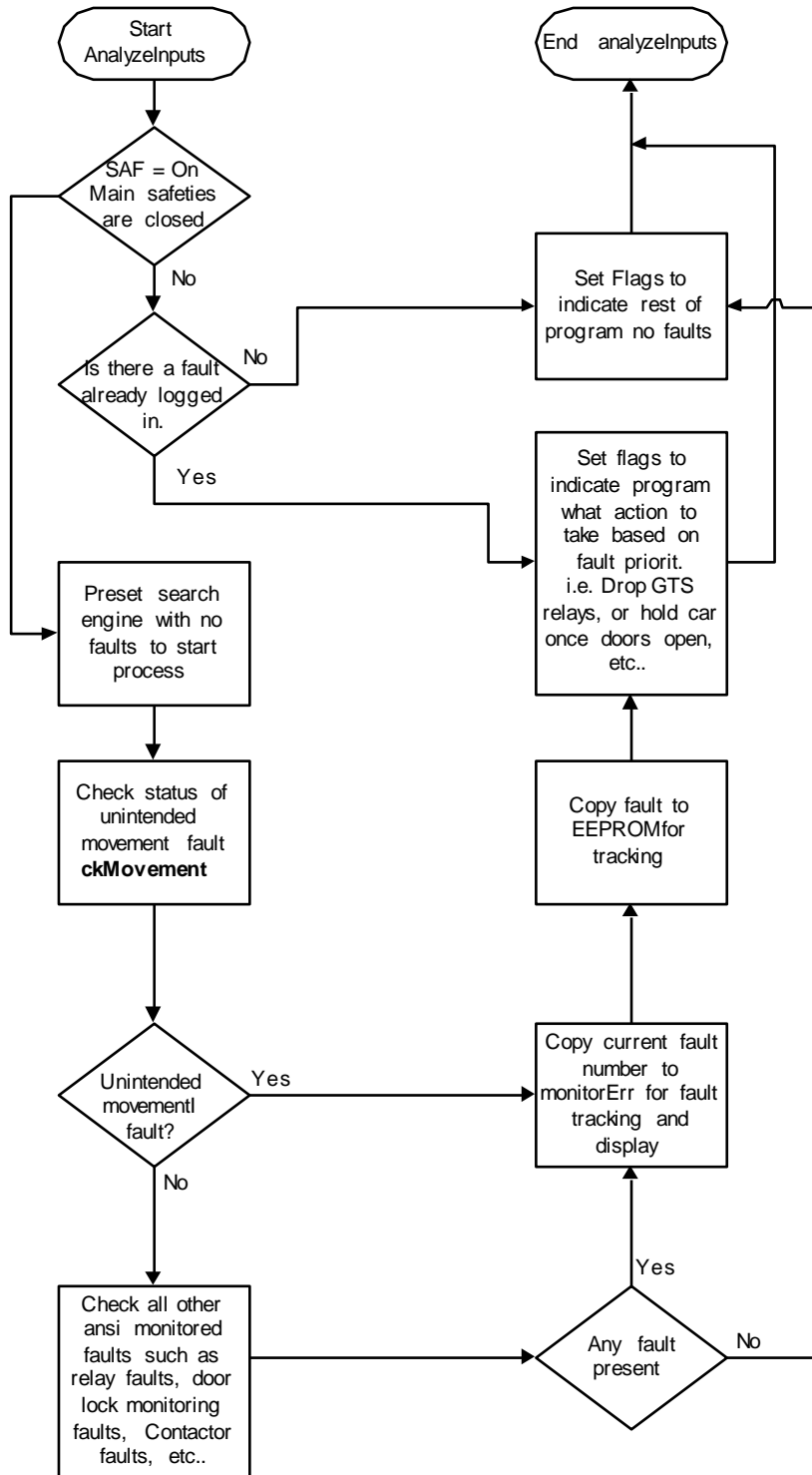

### 5.2.3.3 ASME-A17.1A Fault Reset Process Flow Chart

The following flow chart shows the fault reset process required by the monitoring programs for both latching faults (faults requiring the reset fault input) and not-latching faults (faults which the program will auto reset once the fault condition clears).

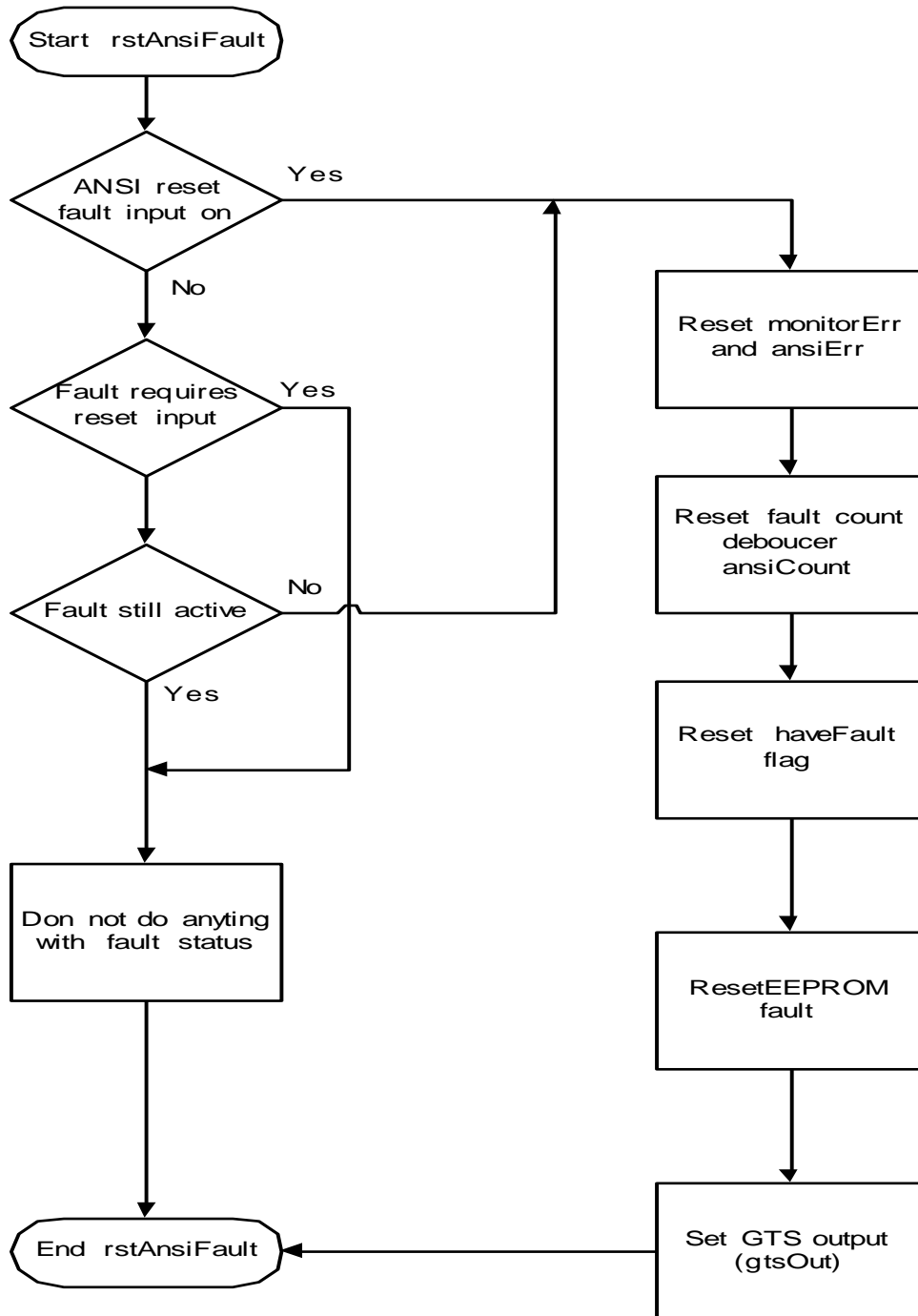

## 5.3 Malfunctions in the Operating System

### 5.3.1 Troubleshooting Doors Operating Improperly or Not at All

Problem	Solution
Blows fused F8 and/or F7 and/or Resistor (RD1) Overheats (25ohms 225W).	Test For: (1) Damage to relays O, C, or CX. (2) Mechanical trouble on door operator on car.
Problem	Solution
No operation of doors, DO and DC relays operate OK, fuses F7 and F8 are OK.	Check: (1) All components in the O, C, and CX relay circuits, and (2) Mechanical trouble on door operator on car.
Problem	Solution
Doors operate one direction only and correct DO and DC relays are operating.	Test for contact closure across proper relay – DC for close, DO for open.
Problem	Solution
Doors operate one direction only. Only one DO or DC relay will operate.	Check DOF/DCF indicator on I/O7 or PIO9 driver board. (Refer to Microprocessor Troubleshooting Guide). Turn "NORMAL-TEST" switch on HLS-7 board to NORMAL."
Problem	Solution
Door speed incorrect at either end of travel. Doors slam or drag.	Check: (1) Slowdown cams that operate slowdown resistors on door operator on car top. Readjust if necessary; and (2) Spring operated door closer on hoistway door.
Problem	Solution
Doors open a few inches or less at one particular landing and appear to be mechanically stuck but re-close so car can leave.	Readjust upper and lower link connections on lift rod for door lock so that lock properly clears lip of enclosure.
Problem	Solution
Other mechanical problems with doors.	Refer to drawings relating to mechanical portions of door operator.

### 5.3.2 Troubleshooting Call Button Problems

Problem	Solution
Car responds to call button but call registration lamp will not light.	<p>After verifying that the bulb is not burned out, check to see if the problem is internal to the controller or in the external wiring. This is most easily observed by noting if associated LED is lit. If it won't show call registration, check for voltage on call common supply. Should the common voltage be correct, replace the associated input/output driver board.</p>
Car will not respond to a specific call.	<p>If the system does not register a call (or a group of calls) but the car functions normally otherwise, the call information is not reaching the computer data storage memory.</p> <p>First make sure that the car and hall call common (terminal 6 for car calls or terminal 50 for hall calls) have proper fixture voltage with respect to 3 buss.</p> <p>Next check the terminals on the controller. One easy method of determining whether the problem is internal to the controller or in the external field wiring is to momentarily jumper 3 to the call terminal number in question. If the car responds to the call, the problem is external.</p> <p>If not: (1) Check that when call terminal is jumpered to terminal 3, the corresponding LED lights up, then refer to microprocessor troubleshooting section to check the computer CCD (HCDX) - Car (Hall) Call Disconnect - function inside computer indicating computer not accepting calls. (2) Replace the associated input/output board.</p>

### 5.3.3 Position Indicator Malfunctions

Problem	Solution
Position indicator out of step with elevator car	<p>The computer system contains automatic synchronizing logic to place the position indicator in step with the car whenever it reaches a terminal landing. Therefore placing a call for a terminal landing should resynchronize the position indicator.</p> <p>Should the car get out of step repeatedly, or the position indicator jumps from terminal to terminal, a stepping problem is indicated. Verify proper operation of the DZ, STU, STD (and ISTU and ISTD, if provided) inputs, making sure that the proper signal LED operates when magnetic switch is on a vane (note that STU/STD, ISTU/ISTD indicators go off when input is active), and signal reaches the appropriate controller input terminal.</p> <p>Also check for missing or damaged hoistway vanes, and make sure that activation of STU or STD does not overlap with activation of DZ or LU/LD.</p>



**NOTE:** The position indicator is strictly under software control and will not respond if the car is moved manually by using the car top inspection station.

## **5.4 Proper Stepping Sequence**

This section is intended to describe the state of the stepping signals required to execute an automatic run, and to illustrate how the elevator computer, P8 or PIO9, keeps track of the car movements as it travels from floor to floor.

### **5.4.1 Initial Selector Status**

While the Car is at a landing floor level...

1. The DZ indicator LED will be lit, indicating car is at floor level.
2. STU/STD signals at IO-7 or PIO9 board LED indicators, or at memory location F000 are lit. Refer to the Field Reprogramming Manual "Memory Flags List" menu.
3. Indicating that stepping inputs are not active, i.e. they are active low.

### **5.4.2 Re-Arming the Selector**

1. As car travels out of the door zone area, the DZ indicator should turn off.
2. The STU (or STD for down) indicator will turn off as the stepping signals from the selector unit are sent to the P8 or PIO9 microprocessor, the Position indicator output will reflect the new floor position.
3. Further activation of STU/STD will be ignored until after DZ is cycled (on/off), "re-arming" the electronic selector for stepping at the next floor.

### **5.4.3 Car Approaching a Stop at Floor**

1. Once the target floor is reached and the target STU/STD signals arrive to the P8 or PIO9 board causing the elevator microprocessor to update position to match the target position.
2. After the last STU/STD signal, the P8 or PIO9 drops the H relay output.
3. As the car travels into the Door Zone area, it is driven into final stopping position by the LU and/or LD leveling sensors.

## **5.5 Valve Problems**

Refer to the manual supplied by the valve manufacturer.

## **5.6 Microprocessor Troubleshooting**

This section is intended to help determine if the Computer Logic Check indicates a faulty board, and if so, which if any of the microprocessor system logic boards is bad so that a good board can be substituted. No attempt has been made to diagnose specific problems that might occur on any particular board, since doing so requires specialized test equipment, which is not generally available to elevator service mechanics in the field.



Assume it has been determined that an output signal is not being sent by the computer system when conditions appear that a signal should be present. The next step is to determine whether the computer is attempting to turn on the output or not, and if not, what might be preventing it from doing so.

To find out what the computer is trying to do or "thinking", look into the computer memory itself using the onboard diagnostics described in the Field Reprogramming Manual.

### **5.6.1 Troubleshooting Example**

For example, let's say you note that the door open output fails to operate door open relay DO in response to a door opening input signal. You observe that the DOFF (door open function) output LED indicator does not turn on. Set the diagnostics switches as described in the Field Reprogramming Manual. Locate the DOFF function on the Memory Flags Listing which indicates an address of F007 for DOFF. Check the LED indicator corresponding to address location F007 and observe that the LED is off.

This tells us the computer is not turning on the Door Open output. This must mean that either the open signal input (say door open button DOBF address F001 is not coming in, or the computer incorrectly thinks doors are already fully open (DOLF - door open limit front input is zero, address F000). Alternatively, the computer may have determined it unsafe to open doors (DZF=0 or HIR=1). Inspection of these flags will show that either (1) an input was not supplied to the system properly, or (2) that the computer cannot see it. In the later case, it is suspected that the I/O7 or PIO9 board (especially if DOBF and DOLF do not track input signals) or ribbon cable connecting the I/O board to the computer board is faulty for standard controllers.

Based on the methods used in this example, any other input/output can be traced to the computer memory to help identify the cause of the fault. The section following illustrates the computer logic used to process the indicated outputs and signals.

## **5.7 Operational Logic Description**

The following description of computer logic control is described in a synthesized format (Boolean logic flow equations). This method of representation is simple to read and understand if the following guidelines are understood:

- a. The logic equations below use signal abbreviations, as listed in the Field Reprogramming Manual, which are referenced in the job prints describing input/output signals. Straightforward signal abbreviations aid understanding (e.g., DOB=door open button, DC=Down Call cancel, etc.).
- b. The small zero superscript used on a signal name indicates that the signal is active when off, or it is otherwise required that the signal go off in order for something else to happen. Thus, DOLF<sup>0</sup> is a signal that, when on, indicates that doors are not fully open. When off, DOLF<sup>0</sup> indicates that doors are fully open.
- c. The plus symbol + is used to indicate an OR function. Thus, the equation: DOB+SE reads, "either door open button input OR safety

edge input". Likewise, the & symbol is used to indicate an AND function. Thus the equation  $DOI \& DOLF^0 = DOF$  reads, "door open intent on AND door open limit off will generate a door open function output". Please note that the words AND and OR are used instead of & and + symbols when combining two smaller equations.

### 5.7.1 Door open function output - DOF

(Demand)  $CCF+UC+DC$  OR (Input)  $DOB+SE+PHE+DHLD$  AND  $DZ = DOI$   
 $DOI \& DOLF^0 = DOF$

### 5.7.2 Door open function rear output - DOF

Same as above, flags are suffixed with letter R: CCFR, UCR, ETC.

### 5.7.3 Computer up output - SU

Start:  $DZ \& DLK^0 \& HIR \& DMU \& DCL^0 = SU$   
 Hold:  $HIR+DZ^0$  AND  $SU \& DLK^0 = SU$

### 5.7.4 Computer down output - SD

Same as SU above, replace DMU/SU with DMD/SD.



**NOTE:** DMU/DMD are the demand flags, which are set any time the computer requires the car to move in response to a call ( $SUA+SDA = 1$ ), car lost ( $BFD+TFD = 1$ ), parking demand ( $UPF+LPF = 1$ ) or fire or emergency recall ( $FRM+EPR$ ).

### 5.7.5 High Speed Output - HR

Start:  $DLK^0 \& EQA^0 \& (DMU \& USD1 + DMD \& DSD1) \& LVL \& DOI^0 = HR$   
 Drop:  $CCT+HCT+CCF+CCR = HR^0$ . Call answered.  
 OR  $DMU^0 \& DMD^0 \& (SU \& STU + SD \& STD) = HR^0$ . Lost demand.  
 OR  $DLK+EQA+(DNS \& DSD1^0)+(UPS \& USD1^0) = HR^0$ . Not safe for HR.

### 5.7.6 Call Disconnect and Reject - CCD, HCDX, HCR

A. CCD – Car call disconnect (Car calls won't latch):

$IN+EPI+FRM+EPS+EQA+MLT+INC+ISR^0+TFD+BFD+CCDFU+CCDFD = CCD$

B. HCDX – Hall call disconnect (Hall calls won't latch):

$FRS^0+FRA^0+EQA^0 = HCDX$ . If duplex both car's flags are considered.

C. HCR – Hall call reject (Calls latch but car won't respond):

$INC+FRM+EQA+TOS+ISR^0+HLW+SAF^0+IN+EPS = HCR$



**NOTE:** Even if  $HCR=0$  ( $CCD=0$ ), Hall (car) calls will be ignored by the computer (even when latched, if the car stopping table indicates that the car should not respond to such a call. See Car stopping table in the Field Reprogramming Manual.

## 5.8 Hardware Logic

### 5.8.1 Computer Power Supply

The proper voltage to the computer board is +5VDC +/-5%; this voltage should be checked at the power supply +OUT to -OUT terminals. Adjust with caution, as a trip out will result if voltage is adjusted too high. To reset a trip, reduce the voltage adjustment, then cycle power.



**CAUTION:** Adjusting output too high will cause the unit to trip.

### 5.8.2 Microprocessor Board

On the microprocessor board there are nine LED's (light emitting diodes), five pushbuttons, and four switches. The On LED for the P8 or the Status LED for PIO9 microprocessor being on indicates that the board is running but not necessarily functioning normally. The eight remaining LED's (in a row) display error/status codes (the LCD display will display this information in English format when provided). In general, the car A/B switch toggles the function of the eight LED's as indicators for CAR A (if the switch is UP) or CAR B (if switch is DOWN). Note that CAR A/B switch is not used for H900 control systems. Refer to the Field Reprogramming Manual for more details on the use of microprocessor PC board switches.



**WARNING:** Do **NOT** depress the microprocessor-reset button while any car is running, as it will cause an emergency stop. Use extreme care.

A group of special conditions are recognized by the microprocessor. If one of these "errors" occurs, a code will be displayed corresponding to that condition. The microprocessor will scroll up to six errors at a time, which show on the LCD display. The eight LED array will display the error that needs to be corrected first, that is, the one with the highest priority.

The field technician should look first to the LED array to identify the error that needs to be corrected first. Error codes can be found in Section 5 of this manual and on the inside of the control equipment enclosure door.

Not all system errors are detected and displayed by the P8 or PIO9; however, the most frequent errors have been programmed to be recognized. Even the fact that the door lock string is open, as it sometimes is during normal operation, is defined with an "error" code, which is frequently displayed during normal.

### 5.8.3 I/O-7 or PIO9 IO Section, Board (I/O-EX board)

The I/O boards perform the task of buffering or protecting the five volt computer logic environment from the electrically noisy 110 volt outside world. For this reason, most microprocessor system problems occur on the I/O boards.

The input buffer section of the I/O accepts high-level inputs from the HLS-7 board or car signals, and converts them to five volts computer signals. The I/O board also provides low-pass filtering to reduce noise susceptibility and Schmitt triggers to increase noise margin.

The relay and signal driver sections of the I/O board provide high voltage switching outputs that actuate relays on the HLS-7 module and general elevator signals.

The output portion of the IO-7 or PIO9 or IO-EX is field replaceable. The replaceable components consist of an output Triac and a Zener diode, which can be identified by the corresponding LED number (i.e. LED 77 corresponds to Triac **Q77** and Zener diode **Z77**).

To determine if the Triac is bad, note that normal behavior of the output will be to turn on such signal as soon as power is applied to the controller. If the Zener diode is shorted, the output will not come on until the controller turns it on, and once turned on it will not be able to be turned off.

Space intentionally left blank

# Section 6 – Group System

## 6.1 Detailed Explanation of the Group Dispatching Subsystem

Since an elevator is a continuous, real-time machine, the supervisory control subsystem microcomputer (or microprocessor) is designed to operate in a loop, performing a predetermined pattern of instructions many times each second. Its speed is such that each elevator control function appears to be continuously monitored. The basic control loop and the functions performed by the computer during each portion of that loop are described below.

## 6.2 Data Acquisition

Before any logic decisions can be made data must be acquired during the first portion of the control loop called "contact scan." The microprocessor interrogates each input (hall calls, car calls, and power subsystem inputs) and saves the data in storage memory. This data is used during the rest of the control loop. In effect, the controller takes a "snapshot" of the entire elevator system, and then it makes decisions based on that information. Snapshots are made many times each second providing functionally continuous system monitoring.

## 6.3 Fireman's Service

After data has been acquired, proper outputs are computed for fireman's service.

## 6.4 Stepping

The next major block in the control loop deals with stepping. The system has no mechanical floor selector so, when power is first applied, the Supervisory Control system checks to see if the car is at the top landing (on the up slowdown limit) or at the bottom landing (on the down slowdown limit). If the car is at either of these locations the internal electronic "selector" is set to the proper value.

If the car happens to be somewhere mid-hoistway when power is first applied, the system will create a phantom call, and run the car until it reaches a terminal landing, whereupon it will become synchronized. After initial synchronization, magnetic vanes placed in the hoistway (STU for step-up and STD for step-down) inform the Supervisory Control System when the car passes each floor. The internal electronic "selector" updates accordingly.

The stepping point is actually one slowdown distance ahead of each floor. When the car steps into any given floor, the control system determines if there are any calls registered for that floor, and if so, initiates a slowdown and cancels the calls. This method requires no mechanical attachments to the car, such as chains, wires, or tapes.

After the controller processes data pertaining to a moving car it scans all calls present and selects a direction preference for the car (if it is not already answering a call).

## **6.5 Door Operation**

The next block in the control loop is concerned with door operation. While the car is running, this portion is bypassed, but when the car enters a door zone this block becomes active. Functions performed by the door-processing block include door holding times (hall call time, car call time, and shortened door time), door opening and closing, and permission to proceed at high speed. The car actually moves in response to signals generated during door control loop processing, since all interlocks and timers (as well as car panel button inputs) must be correct before car movement is allowed.

## **6.6 Indicator Lamps**

The final block of the control loop uses data generated by all previous calculations and calls stored in memory to light the appropriate car panel and hall indicator lamps. Once this has been accomplished, the loop is completed and the processor starts the next contact scan.

The entire loop process is repeated many times each second for a smooth and, to all outward appearances, continuous operation.

It should be noted that the power-up logic, in addition to correctly presetting the floor selector memory location, clears all memory locations and output buffers prior to applying any signals to the power control subsystem, ensuring safe, stable operation.

Space intentionally left blank

# Section 7 – Redundancy Testing Procedure

## 7.1 This Section Describes Test Procedures that Confirm Compliance with Part B, Redundancy & Monitoring in Critical Circuits (ASME 17.1a 2000, Sections 2.26.9.3 and 2.26.9.4)

 **NOTE:** All relays used as critical components are **Safety Relay SR6**, such relays are known as forced guided relays with the characteristics which allow monitoring of one contact and use it to determine the state of the remaining relay contacts.

 **NOTE:** LCD refers to the P8 or PIO9 display unit for all tests below, unless otherwise specified

 **NOTE:** Make sure elevator is placed on TEST mode of operation and elevator cab has been evacuated before proceeding with testing procedure below.

### 7.1.1 Microprocessor Monitoring

**Critical Component:** P8 or PIO9 Microprocessor

**Redundant Component:** P8 or PIO9 and GTS watch dog timers

**Monitored Component:** Memory Checksum, I/O Integrity check

The P8 or PIO9 microprocessor board incorporates a watch dog timer which needs to be refreshed by the program loop every 0.25seconds, a second watch dog timer is used to time out the P8 main safety output for the GTS relay, therefore in the event that the computer were to malfunction the watch dog timer will perform a computer reset and in the event that the computer is not able to reset, the GTS watch dog timer will reset the GTS output, to disable the GTS relay and removing power to Valves and Starter coils.

#### **GTS Watch dog timer test:**

Press the reset button on the P8 or PIO9 and hold it down to prevent the computer from functioning. This will also prevent the onboard microprocessor timeout from updating the GTS output. As a result, GTS relay should drop, resetting the GTS relay outputs opens the power circuit to the Valves and Starter coils.

Print reference to GTS and GTSX contacts 4 is page 1 area 1 of the prints.

To restore, release pressure on the reset button.

#### **P8 or PIO9 Watch dog timer test:**

Turn power off and remove program chip labeled L.Hex, turn power back on and observe the Power on LED on the P8 board blink at the rate of 0.25 seconds demonstrating the effect of the P8 or PIO9 watch dog timer, turn power off to restore program chip.

 **NOTE:** The P8 or PIO9 also performs a memory integrity check for by writing a pattern to the Ram memory and by performing check sums to the program portion of the software and comparing them to default stored values, if the program gets corrupted the computer will display a “Memory Corruption Error” and will disable all outputs.

### **P8 I/O Integrity Check (Standard controller only)**

Turn power off and remove the ribbon cable that connects the P8 to the Monitor board, this should signal the computer that the computer I/O string to the monitor board has failed. The computer display should show, “Safety String Open,” preventing the computer from executing any motion commands.

Restore the ribbon cable into its socket. Make sure socket latching hooks are latched.



**NOTE:** The IO-EX-B44 circuits are part of the PIO9 board.

### **7.1.2 GTS & GTSX Relay Operation and Monitoring**

**Critical Component:** GTS and GTSX Relays

**Redundant Component:** GTSM Computer Monitoring Input

**Monitored Component:** GTS and GTSX Relays contacts

Apply 110 VDC using a jumper from terminal 4A to R13 resistor, located above the HDR relay label, on HLS-7 board. The LCD should show, “GTS Relay Fault”. GTS and GTSX relays should drop, Confirm that the car will not respond to hall or car calls. The latching fault should not clear until the ANSI-RST button is pressed.

### **7.1.3 Stop Relay Proper Operation and Monitoring**

**Critical Component:** STOP Relay

**Redundant Component:** STOPM Computer Monitoring Input

**Monitored Component:** STOP Relay Contacts

Apply 110 VDC using a jumper from terminal 4A to harness connector JSDI-6, STOPM monitor input, located on the top left corner of the HLS-7 board. The LCD should show, “Stop Relay Fault.” Confirm that the car will not respond to hall or car calls. **REMOVE JUMPER.** Car shall return to normal operation once jumper has been removed.

### **7.1.4 DZ Relay Proper Operation and Monitoring**

**Critical Component:** DZ Relay

**Redundant Component:** DZM Computer Monitoring Input

**Monitored Component:** DZ Relay Contacts

On inspection move the car outside door zone area, remove field wire from terminal DZM on HLS-7 board, remove car from inspection. The LCD should show, “Door zone relay fault.” Confirm that the car will not respond to hall or car calls. **Replace wire into DZM terminal** to return Car to normal operation.

### **7.1.5 Leveling Relay Operation and Monitoring**

**Critical Component:** LVL Relay

**Redundant Component:** LVLM Computer Monitoring Input

**Monitored Component:** LVL Relay Contacts

Position the car below or above floor level using Controller Inspection mode, Short resistor R4 to terminal 4A, R4 is located on HLS-7 board below JUP ribbon cable connector. Turn Controller Inspection switch off. The LCD Display should show, “Level Relay Fault.” Confirm that the car will not respond to hall or car calls. **REMOVE JUMPER.** Car shall



return to normal operation once jumper has been removed and ANSI-Reset push button is pressed.

### **7.1.6 Car Gate Relay Operation and Monitoring**

**Critical Component:** CG Relay

**Redundant Component:** DLM Computer Monitoring Input

**Monitored Component:** CG Relay contact.

With the car doors fully closed, DLK LED indicator on IO-7 or PIO9, DCLF LED indicator OFF, apply 110 VDC with a jumper from terminal 4A to terminal SH47 jumper, located above HDR relay label, on HLS-7 board. The LCD should show, “Door Lock Relays Fault.” Confirm that the car will not respond to hall or car calls. **REMOVE JUMPER** car shall return to normal operation once jumper has been removed.

### **7.1.7 Car Stop Bypass Relay Operation and Monitoring**

**Critical Component:** CSB Relay

**Redundant Component:** CSBM Computer Monitoring Input

**Monitored Component:** CSB Relay contact.

With the car level at a floor, remove field wire from terminal 17B on the HLS-7 board, to remove power to CSBM computer input. The LCD should show, “Car stop bypass relay Fault” Confirm that the car will not respond to hall or car calls. Replace wire to 17B Car shall return to normal operation once jumper has been removed.

### **7.1.8 Up direction Relay Operation and Monitoring**

**Critical Component:** U Relay

**Redundant Component:** UPS Computer Monitoring Input

**Monitored Component:** U Relay contact.

With the car level at the floor remove the U relay from its socket on the HLS-7 board, to remove power to UPS computer input. The LCD should show, “PUMP Protection Timer” after a couple of seconds. Confirm that the car will not respond to hall or car calls. To reset fault momentary place the car on controller inspection, and press the ANSI-Reset button.

### **7.1.9 Down direction Relay Operation and Monitoring**

**Critical Component:** D Relay

**Redundant Component:** DNS Computer Monitoring Input

**Monitored Component:** D Relay contact.

With the car level at the floor remove the D relay from its socket on the HLS-7 board, to remove power to DNS computer input. The LCD should show, “Down Relay Fault” after a couple of seconds. Confirm that the car will not respond to hall or car calls. To reset fault momentary place the car on controller inspection, and press the ANSI-Reset button.

### **7.1.10 High Speed, Contactor Aux., Contactor Relays Operation and Monitoring**

**Critical Component:** H, AA, Delta Relays

**Redundant Component:** STPM Computer Monitoring Input

**Monitored Component:** H, AA, Delta Aux. Relay contact.

With the car level at a floor, remove H relay from its socket on the HLS-7 board, to remove power to STPM computer input. The LCD should show, “Contactor Drop relay Fault” Confirm that the car will not respond to hall or car calls. Replace H relay Car shall return to normal operation once jumper has been removed. Repeat for AA relay and for Delta Auxiliary manually press contactor instead of removing wiring

### **7.1.11 High Speed HR Relay output Operation and Monitoring**

**Critical Component:** H Relay

**Redundant Component:** USD2 and DSD2 Terminal Slowdowns and STU and STD stepping Signals, and Computer Monitoring Inputs.

**Monitored Component:** USD2 and DSD2 Terminal Slowdown switches.

#### **USD2 and DSD2 inputs test:**

Place car on test mode of operation and verify car runs to all floors and stops and levels into position without generating faults to verify all selector signals normal operation.

Move the car to an intermediate landing and remove field wire from terminal 32, verify computer will reset elevator position indicator to top floor, replace wire to terminal 32 and remove wire from terminal 35, verify computer will reset floor position indicator to bottom floor.

#### **DSD2 test:**

On Test mode of operation move the car away from bottom floor to another landing, then jump D31 anode to ground, this will pick up H (high speed relay) upon getting a command to run. Remove wire from terminal 72, STD signal preventing the computer from stepping the car down. Place a car call to the bottom floor; upon arrival to the bottom floor the car will slow down and will make a normal stop into the bottom floor.

Replace wire to terminal 72, remove jumper to D31 diode, and momentarily place car on inspection to clear out of step fault.

#### **USD2 test:**

On Test mode of operation move the car away from top floor to another landing, then jump D31 anode to ground, this will pick up H (high speed relay) upon getting a command to run. Remove wire from terminal 71, STU signal preventing the computer from stepping the car up. Place a car call to the top floor; upon arrival to the top floor the car will slow down and will make a normal stop into the top floor.

Replace wire to terminal 71, remove jumper to D31 diode, and momentarily place car on inspection to clear out of step fault.

### **7.1.12 LVLO Relay output Operation and Monitoring**

**Critical Component:** LU and LD Selector signals

**Redundant Component:** LVLO Computer output & LVL relay.

**Monitored Component:** LU & LD, LVLM input.

Place car on test mode of operation and make several one and multi floor runs, observe that the LVLO output LED on IO-7 or PIO9 board and that the LVL Relay energizes only when the car comes into leveling zone of target floor independently of the LU and LD inputs. Please refer to test 4 above for LVL Relay test for LVL relay test.

### **7.1.13 DZ1 and DZ2 Selector signals Operation and Monitoring**

**Critical Component:** DZ1 and DZ2 Selector signals

**Redundant Component:** DZI, DZM Computer inputs and DZ relay.

**Monitored Component:** DZ relay and DZI, DZM computer inputs.

Place car on test mode of operation and make several one and multi floor runs, observe that the DZ input t LED on IO-7 or PIO9 board come on and the DZM input goes off as the car passes over the trucking zone but the car continues to move in high speed only allowing leveling and door operation at the target floor. Refer to test 3 above for DZ relay test and unintended movement test below for further monitoring of the DZ1 and DZ2 inputs.

### **7.1.14 Hall & Car Door Bypass Switch Operation and Monitoring**

**Critical Component:** Hall and Car Door Bypass Switches

**Redundant Component:** HDBM Computer Monitoring Input

**Monitored Component:** Hall and Car Door Bypass Switches Contacts

Jump R15 resistor top to ground, R15 is located above the STOP relay on HLS board. The LCD should show, "Door Bypass System Fault." Confirm that the car will not respond to hall or car calls. **REMOVE JUMPER.** Car shall return to normal operation once jumper has been removed

Place the car on Automatic Operation and open the hall and/or car doors, the DLK LED should be off. Turn on Car Door Bypass and/or Hall Door Bypass switch(s) as necessary. Verify that the controller mode of operation changes to Inspection.

On the controller relay board, flip the Inspection Switch to "ON." Flip the run switch "Up" and then "Down" and confirm that the car will not run on inspection. Turn on Car Door Bypass and/or Hall Door Bypass switch(s) off, and press the ANSI-Reset push button to return car to normal operation.



**NOTE:** If the hoistway door or car door is bypassed, the elevator controller will prevent the car from being run using the machine room inspection circuit or on access inspection mode, the car will only be allowed to move on Car Top Inspection mode of operation.

### **7.1.15 Detection of Jumpers on Door Safety String**

**Critical Component:** Car Gate and Hoistway Door Locks

**Redundant Component:** CG Relay

**Monitored Component:** CG, THD, DLK and DCL Computer Monitoring Input

With the car on automatic operation, place a jumper from terminal 4 to CG on the HLS-7 board. Press the Door Open button and allow doors to fully open. The LCD should show, “Door lock system fault.” Confirm that the car will not respond to hall or car calls.

**REMOVE JUMPER.** Car shall return to normal operation once jumper has been removed.

With the car on Automatic Operation, place a jumper from terminal 4 to THD on the HLS-7 board. Press the Door Open button and allow doors to fully open. The LCD should show, “Door Lock System Fault.” Confirm that the car will not respond to hall or car calls.

**REMOVE JUMPER.** Car shall return to normal operation once jumper has been removed. Place the car on Inspection Mode and verify that the car will not respond to hall or car calls.

### **7.1.16 Door Open and Closed Simultaneously**

**Critical Component:** Door Opened & Door Closed Limits

**Redundant Component:** DOL and DCL Computer Monitoring Inputs

**Monitored Component:** Door Opened & Door Closed Limits

Place a jumper from the Terminal DOB to terminal 4 on the IO-7 or PIO9 board and allow the doors to open fully. Confirm that the DOLF LED indicator on the IO-7 or PIO9 board is off, and remove the DCLF input wire from IO-7 or PIO9. The LCD should show, “Front Door Limit Switches Fault.” Confirm that the car will not respond to hall or car calls.

**REMOVE JUMPER** and reattach DCLF input wire to return car to normal operation.

### **7.1.17 Revert to Automatic Operation (ASME 2.26.9.3.d)**

**Critical Component:** IN Computer Input, SU or SD Computer Outputs

**Redundant Component:** IN, and STOP relays

**Monitored Component:** INM, and STOPM Computer Monitoring Inputs

With the car on Inspection operation, place a jumper from D20 or D26 diode anodes on the HLS-7 board to terminal 3 “ground.” These diodes are in series with the computer SU and SD direction relay outputs. Confirm that the car will not move and will not respond to any car or hall call demand.

**REMOVE JUMPER.** Return the car to Normal mode of operation.

### **7.1.18 Unintended Movement (ASME 2.19.2)**

**Critical Component:** DZ, and LVL Relays

**Redundant Component:** DZ, and LVL Contacts

**Monitored Component:** DZM, LVLM, CG, and THD Computer Monitoring Inputs

Place a jumper from the Terminal DOBF to terminal 4 on the IO-7 or PIO9 board and allow the doors to open fully. Confirm that the DOLF LED indicator on the IO-7 or PIO9 board is off. Turn power off, remove wires from 27 and DZM terminals located on HLS-7 board. Restore power.

The LCD should show, “Unintended Movement System Fault.” Relays GTS and GTSX should drop, setting the emergency brake and opening the directional circuits. Turn power off and rewire terminals 27 and DZM. Confirm that the error does not reset by cycling power. The latching fault should not clear until the ANSI-RST button is pressed.

### **7.1.19 Single Ground**

**Critical Component:** N/A

**Redundant Component:** N/A

**Monitored Component:** N/A

Short terminal 4 located on the controller power terminal strip, (not on the any of the PC boards) to ground. Fuse F4 should blow removing power to all elevator control relay logic disabling all controller functions. Turn power off, and replace fuse.

Space intentionally left blank

# Section 8 – Maintenance

## 8.1 Maintenance

The Elevator Controls Microprocessor Elevator Controller has been designed to require as little routine maintenance as possible. The mechanical interconnections are the least reliable portion of the solid-state system, so the less they are disturbed, the more likely the system is to continue to function properly.

The elevator itself, however, is a complex mechanical apparatus, which requires periodic routine preventive maintenance. In addition to lubrication of the various moving parts, door lock contacts should be cleaned and inspected regularly since exposed contacts are susceptible to dirt and corrosion. The doors also receive the heaviest wear, often making two or even three cycles at a floor.

The various rotating machinery belts and couplings should be routinely inspected for wear. Wear could cause loss of control of the elevator car.

If the elevator system develops problems or becomes inoperative refer to the Troubleshooting guide Section 5 of this manual.

## 8.2 Replacement Parts List

### 8.2.1 Elevator Controls PC Boards

- 1) P8 Main microprocessor board (Standard controllers only)
- 2) IO-7-Vxx Main input-output board (Standard controllers only)
- 3) IOEX-B44 ASME-17.1A-2000 monitoring board (Standard controllers only)
- 4) IOEX-Vxx Input-output expander board.
- 6) PIO9 Main microprocessor board (Prodigy controllers only)

### For EZ-Link systems only

- 1) P8X Controller to serial link microprocessor board (Standard controllers only)
- 2) TOC Car top microprocessor board.
- 3) COP Car panel microprocessor board.
- 4) Hall Microprocessor for hall stations.
- 5) COP/TOC-EX Car top or COP extender board.



**NOTE:** xx is the fixture voltage

### **8.2.2. Relays**

4 pole ice-cube 120 VAC  
P&B KHAU-17A12N-120  
Omron MY4AC110/120S  
Idec RU4S-D12

4 pole ice-cube 110 VDC  
P&B KHAU-17D12N-110  
Omron MY4-DC12S  
Idec RU4S-A12

3 pole ice-cube 110 VDC  
P&B KUP-14D35-110  
Omron RR3B-ULDC110V

Power 2 poles 30-amp 110VDC relay with DC Blow-outs  
P&B PRD11DH0-110VDC

Force guided relay  
Shrack SHRACK V23050-A1110-A533, 110 VDC

### **8.2.3 Fuses**

AGC ¼, 1, 2, 3, 5, 6,10, 15 AMP 250VOLT  
MDA TYPE 3, 5, 10 & 15 AMP 250 VOLT  
FRN-R 10, 20, 30, 60 AMP 250 VOLT (208 to 240 VAC power supply)  
FNQ 5,10,15A 500 VOLT (440 to 480 VAC power supply)

### **8.2.4 Power Supply**

Power One HB5-3/0VP 3-AMPS @ 5VDC

### **8.2.5 Semiconductors**

Motorola HEP-RO170  
Motorola 1N5347B – 10V, 5 Watt, Zener Diode  
Motorola 1N5333B – 3.3V, 5 Watt, Zener Diode  
Tecor L4004F31 – 4 AMP, 400 VOLT, Sensitive Gate Triac